

# TECHNICAL CATALOGUE

**HITACHI**

Cooling & Heating



## MULTIZONE

OUTDOOR UNIT  
RAM-S24U3HLAE

INDOOR  
RAS-EH07QHLAE  
RAS-EH(09-18)RHLAE  
RAS-SH07QHLAE  
RAS-SH(09-18)RHLAE  
RAD-SH(07-18)QHLAE  
RAI-SH(07-18)QHLAE  
RAF-SH(07-18)QHLAE



# HITACHI

**Specifications in this catalogue are subject to change without prior notice in order for HITACHI to bring in the latest innovations to their customers**

**Whilst every effort is made to ensure that all dimensions and specifications are correct, any printers' error not rectified are outside the control of HITACHI, who cannot be held responsible for the same**



# CONTENTS

<b>CONTENTS</b>	<b>1</b>
<b>1 SPECIFICATIONS</b>	<b>1-1</b>
1.1. MULTIZONE INDOOR	1-2
1.1.1. WALL TYPE (RAS-EH07QHLAE, RAS-EH09/12RHLAE)	1-2
1.1.2. WALL TYPE (RAS-EH18RHLAE)	1-3
1.1.3. WALL TYPE (RAS-SH07QHLAE, RAS-SH09/12RHLAE)	1-4
1.1.4. WALL TYPE (RAS-SH18RHLAE)	1-5
1.1.5. FLOOR TYPE (RAF-SH07/09/12/18/QHLAE)	1-6
1.1.6. CEILING CASSETTE (RAI-SH07/09QHLAE)	1-7
1.1.7. CEILING CASSETTE (RAI- SH12/18QHLAE)	1-8
1.1.8. DUCT TYPE (RAD-SH07/09/12QHLAE)	1-9
1.1.9. DUCT TYPE (RAD-SH18QHLAE)	1-10
1.1.10. DUCT STATIC PRESSURE AND AIR FLOW (RAD-SH07/09/12QHLAE)	1-11
1.1.11. DUCT STATIC PRESSURE AND AIR FLOW (RAD-SH18QHLAE)	1-12
1.2. MULTIZONE OUTDOOR (RAM-S24U3HLAE)	1-13
<b>2 DIMENSIONAL DATA</b>	<b>2-1</b>
2.1. MULTIZONE INDOOR UNITS	2-2
2.1.1. WALL TYPE (RAS-EH07QHLAE, RAS-EH09/12/18RHLAE)	2-2
2.1.2. WALL TYPE (RAS-SH18RHLAE)	2-3
2.1.3. WALL TYPE (RAS-SH07QHLAE, RAS-SH09/12RHLAE)	2-4
2.1.4. FLOOR TYPE (RAF-SH07/09/12/18/QHLAE)	2-5
2.1.5. CEILING CASSETTE (RAI- SH07/09/12/18QHLAE)	2-6
2.1.6. DUCT TYPE (RAD-SH07/09/12QHLAE)	2-7
2.1.7. DUCT TYPE (RAD-SH18QHLAE)	2-8
2.2. MULTIZONE OUTDOOR UNITS (RAM-S24U3HLAE)	2-9
<b>3 CAPACITIES AND SELECTION DATA</b>	<b>3-1</b>
3.1. SYSTEM SELECTION PROCEDURE	3-2
3.1.1. SELECTION UNIT FEATURES	3-2
3.1.2. SELECTION GUIDE	3-2
3.2. CAPACITY CHARACTERISTIC CURVES FOR MULTIZONE	3-3
3.3. CORRECTION FACTORS ACCORDING TO PIPING LENGTH	3-8
3.4. CORRECTION FACTORS ACCORDING TO DEFROSTING OPERATION	3-10
3.5. COMBINATION TABLE FOR MULTIZONE OUTDOOR	3-11
<b>4 SOUND DATA</b>	<b>4-1</b>
4.1. SOUND DATA (RAM-S24U3HLAE)	4-2
<b>5 WORKING RANGE</b>	<b>5-1</b>
5.1. POWER SUPPLY	5-2
5.2. WORKING RANGE	5-2
5.2.1. MULTIZONE	5-2
<b>6 ELECTRICAL DATA</b>	<b>6-1</b>
6.1. INDOOR UNIT	6-2
6.2. OUTDOOR UNIT	6-3



<b>7</b>	<b>WIRING DIAGRAM</b>	<b>7-1</b>
7.1.	MULTIZONE	7-2
7.1.1.	RAS-EH07QHLAE, RAS-EH09/12/18RHLAE	7-2
7.1.2.	RAS-SH07QHLAE, RAS-SH09/12RHLAE	7-3
7.1.3.	RAS-SH18RHLAE	7-4
7.1.4.	RAF-SH07/09/12/18QHLAE	7-5
7.1.5.	RAI- SH07/09/12/18QHLAE	7-6
7.1.6.	RAD-SH07/09/12QHLAE	7-7
7.1.7.	RAD-SH18QHLAE	7-8
7.2	RAM-S24U3HLAE	7-9
<b>8</b>	<b>REFRIGERANT CYCLE</b>	<b>8-1</b>
8.1.	MULTIZONE INDOOR UNITS	8-2
8.1.1.	WALL TYPE (RAS-EH07QHLAE, RAS-EH09/12RHLAE)	8-2
8.1.2.	WALL TYPE (RAS-EH18RHLAE)	8-3
8.1.3.	WALL TYPE (RAS-SH07QHLAE, RAS-SH09/12RHLAE)	8-4
8.1.4.	WALL TYPE (RAS-SH18RHLAE)	8-5
8.1.5.	FLOOR TYPE (RAF-SH07/09/12QHLAE)	8-6
8.1.6.	FLOOR TYPE (RAF-SH18QHLAE)	8-7
8.1.7.	CEILING CASSETTE (RAI- SH07/09/12/18QHLAE)	8-8
8.1.8.	DUCT TYPE (RAD-SH07/09/12QHLAE)	8-9
8.1.9.	DUCT TYPE (RAD-SH18QHLAE)	8-10
8.2.	MULTIZONE OUTDOOR UNITS (RAM-S24U3HLAE)	8-11
<b>9</b>	<b>CONTROL AND FUNCTION</b>	<b>9-1</b>
9.1.	WIRELESS REMOTE CONTROL FUNCTION	9-2
9.1.1.	RAR-M0B3, RAR-M0B4, RAR-M0B5 AND RAR-M0B6	9-2
9.2.	SHIFT VALUE	9-3
9.3.	OPERATION LOCK	9-5
9.4.	SETTING THE PREVENTION OF MUTUAL INTERFERENCE	9-6
9.5.	INTERMITTENT FAN SPEED SETTING	9-6
9.6.	FAN SPEED SETTING IN THERMO OFF IN COOLING	9-7
9.7.	ERROR CODE INFORMATION	9-8
9.8.	ADDITIONAL FUNCTION VIA DIP-SWITCH SETTINGS	9-10
9.8.1.	AUTO RESTART FUNCTION	9-10
9.8.2.	HEATING/COOLING ONLY MODE SELECTION	9-10
9.9.	WIRELESS REMOTE CONTROL FUNCTION	9-11
9.10.	SHIFT VALUE	9-13
9.11.	DISPLAY OPERATION MODE SETTING	9-14
9.12.	HOW TO CHANGE THE INTERMITTENT FAN CONTROL SETTING	9-15
9.13.	HOW TO CHANGE THE FAN SPEED IN COOLING MODE DURING THERMO OFF	9-16
9.14.	SETTING THE PREVENTION OF MUTUAL INTERFERENCE	9-17
<b>10</b>	<b>OPTION LIST</b>	<b>10-1</b>
10.1.	WIRED REMOTE CONTROL SPX-RCDA1 AND SPX-RCDB1	10-2
10.1.1.	SHIFT VALUE	10-3
10.1.2.	ERROR CODE INFORMATION	10-4
10.2.	WIRED REMOTE CONTROL SPX-WKT4	10-7
10.2.1.	SERVICE MENU OPERATION	10-8
10.2.1.1.	SERVICE MENU	10-8



10.2.1.2.	DISPLAY ROOM TEMPERATURE _____	10-9
10.2.1.3.	CONTACT INFORMATION REGISTRATION _____	10-9
10.2.1.4.	LIMIT OPERATION _____	10-10
10.2.1.5.	SHIFT CHANGE _____	10-11
10.2.1.6.	INTERMITTENT FAN CONTROL _____	10-12
10.2.1.7.	FAN SPEED DURING THERMO OFF _____	10-13
10.2.1.8.	OPERATION LOCK _____	10-14
10.2.1.9.	DISPLAY MALFUNCTION _____	10-15
10.2.1.10.	DISPLAY ALARM HISTORY _____	10-16
10.2.1.11.	DEFROSTING INHIBIT PERIOD SELECTION _____	10-17
10.2.1.12.	ECO AUTO OFF _____	10-18
10.2.1.13.	CLEAN (SERVICE) _____	10-19
10.2.1.14.	KEY LOCK _____	10-19
10.2.2.	CHECK MENU OPERATION _____	10-20
10.2.2.1.	SELF CHECKING _____	10-20
10.3.	H-LINK ADAPTOR – PSC 6RAD _____	10-23
10.3.1.	SAFETY SUMMARY _____	10-23
10.3.2.	INSTALLATION WORK _____	10-23
10.3.3.	ELECTRICAL WIRING _____	10-24
10.3.4.	DIP SWITCH SETTING _____	10-25
10.3.5.	TEST RUN _____	10-26
10.4.	DRY CONTACT (SPX-WDC2 AND SPX-WDC3) APPLICATION (USING DIP SWITCH) _____	10-27
10.5.	DISTRIBUTOR – SPX-DST1 _____	10-30
10.6.	REMOTE SENSOR - SPX-RTH1 _____	10-31
10.6.1.	SELECTION OF INSTALLATION POSITION _____	10-31
10.6.2.	INSTALLATION PROCEDURE _____	10-31
10.6.3.	WIRING PROCEDURES _____	10-31



# 1 SPECIFICATIONS

## CONTENTS

<b>1</b>	<b>SPECIFICATIONS</b>	<b>1-1</b>
1.1.	MULTIZONE INDOOR	1-2
1.1.1.	WALL TYPE (RAS-EH07QHLAE, RAS-EH09/12RHLAE)	1-2
1.1.2.	WALL TYPE (RAS-EH18RHLAE)	1-3
1.1.3.	WALL TYPE (RAS-SH07QHLAE, RAS-SH09/12RHLAE)	1-4
1.1.4.	WALL TYPE (RAS-SH18RHLAE)	1-5
1.1.5.	FLOOR TYPE (RAF-SH07/09/12/18/QHLAE)	1-6
1.1.6.	CEILING CASSETTE (RAI-SH07/09QHLAE)	1-7
1.1.7.	CEILING CASSETTE (RAI- SH12/18QHLAE)	1-8
1.1.8.	DUCT TYPE (RAD-SH07/09/12QHLAE)	1-9
1.1.9.	DUCT TYPE (RAD-SH18QHLAE)	1-10
1.1.10.	DUCT STATIC PRESSURE AND AIR FLOW (RAD-SH07/09/12QHLAE)	1-11
1.1.11.	DUCT STATIC PRESSURE AND AIR FLOW (RAD-SH18QHLAE)	1-12
1.2.	MULTIZONE OUTDOOR (RAM-S24U3HLAE)	1-13



**1.1. MULTIZONE INDOOR****1.1.1. WALL TYPE (RAS-EH07QHLAE / EH09RHLAE / EH12RHLAE)**

INDOOR	Unit	RAS-EH07QHLAE	RAS-EH09RHLAE	RAS-EH12RHLAE
Nominal capacity adjustable		no	no	no
Nominal Cooling capacity (min - max)	BTU	7000(3050-9000)	9000(5450~10500)	12000(5500~13200)
Cooling sensible capacity	BTU	-	-	-
Nominal Heating capacity (min - max)	BTU	9000(3050-10900)	10500(4200~11500)	13000(4400~14500)
Noise level cooling (sound pressure) (SL / L / M / H)	dB(A)	29/36/40/42	29/36/40/42	29/36/40/44
Noise level heating (sound pressure) (SL / L / M / H)	dB(A)	29/36/40/42	29/36/40/42	29/36/40/44
Noise level (sound power) *match with Fiche/ Eurovent/Product Info	dB(A)	56	56	58
Air flow cooling mode (SL / L / M / H)	cfm (m³/h)	170/218/250/290	170/218/250/290	170/218/250/320
Air flow heating mode (SL / L / M / H)	cfm (m³/h)	170/218/250/290	170/218/250/290	170/218/250/320
Fan Motor	W			
Dehumidification	l/h	1.0	1.4	1.6
Included drain pump *for RAI/RAD	yes/no	no	no	no
Max. height available for drain pump (RAD/RAI only)	in. (mm)	no	no	no
Drain pump pressure lift *for RAI/RAD	in. (mm)	no	no	no
Static pressure switch at High(L / M / H) *for RAD	Pa (m3/h)	no	no	no
Dimensions (H x W x D)	in. (mm)	11.07x30.70x9.05 (280x780x230)	11.07x30.70x9.05 (280x780x230)	11.07x30.70x9.05 (280x780x230)
Weight *must match with Packing data information	lbs. (kg)	20.9 (9.5)	20.9 (9.5)	20.9 (9.5)
Panel weight *for RAI	lbs. (kg)	-	-	-
Panel dimensions (H x W x D) *for RAI	in. (mm)	-	-	-
Colour (Munsell Code)				
Condensate Drain	in. (mm)	-	-	-
Panel reference		-	-	-
Color of the panel (RAL)		-	-	-
Running current (C/H) *for single split indoor&outdoor must be matched	A	-	-	-
Power supply	V	FROM OUTDOOR	FROM OUTDOOR	FROM OUTDOOR
Cable section (interconnection/*if power supply is connected to indoor)	mm²	0.8x 3+EARTH/-	0.8x 3+EARTH/-	0.8x 3+EARTH/-
Piping diameter (Liq / Gas)	Inch	1/4" / 3/8"	1/4" / 3/8"	1/4" / 3/8"
Drain diameter (ext)	in. (mm)	0.63(16)	0.63(16)	0.63(16)
Remote control (standard/optional) *	Standard	RAR-MOB5	RAR-MOB5	RAR-MOB5
	Optional	SPX-RCDB1/SPX-WKT4	SPX-RCDB1/SPX-WKT4	SPX-RCDB1/SPX-WKT4
<b>Filter</b>				
ACL Filter Standard (Material & Accessory code)		Active Carbon / SPX-CFH22AC25	Active Carbon / SPX-CFH22AC25	Active Carbon / SPX-CFH22AC25
ACL Filter Standard Dimensions (H x W x D)	in. (mm)	(48x243x5)	(48x243x5)	(48x243x5)
ACL Filter Optional (Material - Accessory code)		-	-	-
Pre-filter Standard Material		STAINLESS	STAINLESS	STAINLESS
Pre-filter Optional (Material & Accessory code)		-	-	-

**NOTE:**

1. Capacity and seasonal performance data (SEER /HSPF) are based on AHRI 210-240. The nominal heating and cooling capacity is the combined capacity of the HITACHI Split system (Indoor + Outdoor Unit).

Operation Conditions		Cooling	Heating
Indoor Air Inlet Temperature	dB	80 °F	70 °F
	WB	67 °F	
Outdoor Air Inlet Temperature	dB	95 °F	47 °F
	WB		43 °F

Piping Length: 7.5 meters; Piping Lift: 0 meter  
dB: Dry Bulb; WB: Wet Bulb

2. The Sound Pressure Level is based on the following conditions:

- 0.8 meter beneath indoor height center
- 1 meter from Discharge grille

The above data was measured in an anechoic chamber so that reflected sound should be taken into consideration when installing the unit.



## 1.1.2. WALL TYPE (RAS-EH18RHLAE)

INDOOR	Unit	RAS-EH18RHLAE
Nominal capacity adjustable		no
Nominal Cooling capacity (min - max)	BTU	17600(5700~18600)
Cooling sensible capacity	BTU	-
Nominal Heating capacity (min - max)	BTU	19000(6700~20500)
Noise level cooling (sound pressure) (SL / L / M / H)	dB(A)	35/38/42/48
Noise level heating (sound pressure) (SL / L / M / H)	dB(A)	35/38/42/48
Noise level (sound power) *match with Fiche/ Eurovent/Product Info	dB(A)	62
Air flow cooling mode (SL / L / M / H)	cfm (m³/h)	200/240/280/400
Air flow heating mode (SL / L / M / H)	cfm (m³/h)	200/240/280/400
Fan Motor	W	
Dehumidification	l/h	2.9
Included drain pump *for RAI/RAD	yes/no	no
Max. height available for drain pump (RAD/RAI only)	in. (mm)	no
Drain pump pressure lift *for RAI/RAD	in. (mm)	no
Static pressure switch at High(L / M / H) *for RAD	Pa (m3/h)	no
Dimensions (H x W x D)	in. (mm)	11.07x30.70x9.05 (280x780x230)
Weight *must match with Packing data information	lbs. (kg)	20.9 (9.5)
Panel weight *for RAI	lbs. (kg)	-
Panel dimensions (H x W x D) *for RAI	in. (mm)	-
Colour (Munsell Code)		
Condensate Drain	in. (mm)	-
Panel reference		-
Color of the panel (RAL)		-
Running current (C/H) *for single split indoor&outdoor must be matched	A	-
Power supply	V	FROM OUTDOOR
Cable section (interconnection/*if power supply is connected to indoor)	mm²	0.8x 3+EARTH/-
Piping diameter (Liq / Gas)	Inch	1/4" / 1/2"
Drain diameter (ext)	in. (mm)	0.63(16)
Remote control (standard/optional) *	Standard	RAR-MOB05
	Optional	SPX-RCDB1/SPX-WKT4
<b>Filter</b>		
ACL Filter Standard (Material & Accessory code)		Active Carbon / SPX-CFH22AC25
ACL Filter Standard Dimensions (H x W x D)	in. (mm)	(48x243x5)
ACL Filter Optional (Material - Accessory code)		-
Pre-filter Standard Material		STAINLESS
Pre-filter Optional (Material & Accessory code)		-

**NOTE:**

- Capacity and seasonal performance data (SEER /HSPF) are based on AHRI 210-240. The nominal heating and cooling capacity is the combined capacity of the HITACHI Split system (Indoor + Outdoor Unit).

Operation Conditions		Cooling	Heating
Indoor Air Inlet Temperature	dB	80 °F	70 °F
	WB	67 °F	
Outdoor Air Inlet Temperature	dB	95 °F	47 °F
	WB		43 °F
Piping Length: 7.5 meters; Piping Lift: 0 meter dB: Dry Bulb; WB: Wet Bulb			

- The Sound Pressure Level is based on the following conditions:

- 0.8 meter beneath indoor height center
- 1 meter from Discharge grille

The above data was measured in an anechoic chamber so that reflected sound should be taken into consideration when installing the unit.



## 1.1.3. WALL TYPE (RAS-SH07QHLAE / SH09RHLAE / SH12RHLAE)

INDOOR	Unit	RAS-SH07QHLAE	RAS-SH09RHLAE	RAS-SH12RHLAE
Nominal capacity adjustable		no	no	no
Nominal Cooling capacity (min - max)	BTU	7000(3050-9000)	9000(5100~10500)	12000(5150~14000)
Cooling sensible capacity	BTU	-	-	-
Nominal Heating capacity (min - max)	BTU	9000(3050-10900)	11000(5450~15000)	14000(5500~18000)
Noise level cooling (sound pressure) (SL / L / M / H)	dB(A)	27/35/40/43	27/35/40/43	27/35/40/46
Noise level heating (sound pressure) (SL / L / M / H)	dB(A)	27/35/40/43	27/35/40/43	27/35/40/46
Noise level (sound power) *match with Fiche/ Eurovent/Product Info	dB(A)	57	57	60
Air flow cooling mode (SL / L / M / H)	cfm (m³/h)	150/200/280/320	150/200/280/320	150/200/280/400
Air flow heating mode (SL / L / M / H)	cfm (m³/h)	180/230/310/330	180/230/310/330	180/230/310/400
Fan Motor	W			
Dehumidification	l/h	1.0	1.0	1.5
Included drain pump *for RAI/RAD	yes/no	no	no	no
Max. height available for drain pump (RAD/RAI only)	in. (mm)	no	no	no
Drain pump pressure lift *for RAI/RAD	in. (mm)	no	no	no
Static pressure switch at High(L / M / H) *for RAD	Pa (m3/h)	no	no	no
Dimensions (H x W x D)	in. (mm)	11.81x35.43x9.05 (300x900x230)	11.81x35.43x9.05 (300x900x230)	11.81x35.43x9.05 (300x900x230)
Weight *must match with Packing data information	lbs. (kg)	28.7 (13)	28.7 (13)	28.7 (13)
Panel weight *for RAI	lbs. (kg)	-	-	-
Panel dimensions (H x W x D) *for RAI	in. (mm)	-	-	-
Colour (Munsell Code)				
Condensate Drain	in. (mm)	-	-	-
Panel reference		-	-	-
Color of the panel (RAL)		-	-	-
Running current (C/H) *for single split indoor&outdoor must be matched	A	-	-	-
Power supply	V	FROM OUTDOOR	FROM OUTDOOR	FROM OUTDOOR
Cable section (interconnection/*if power supply is connected to indoor)	mm²	0.8x 3+EARTH/-	0.8x 3+EARTH/-	0.8x 3+EARTH/-
Piping diameter (Liq / Gas)	Inch	1/4" / 3/8"	1/4" / 3/8"	1/4" / 3/8"
Drain diameter (ext)	in. (mm)	0.63(16)	0.63(16)	0.63(16)
Remote control (standard/optional) *	Standard	RAR-MOB6	RAR-MOB6	RAR-MOB6
	Optional	SPX-WKT4	SPX-WKT4	SPX-WKT4
<b>Filter</b>				
ACL Filter Standard (Material & Accessory code)		Active Carbon / SPX-CFH22AC25	Active Carbon / SPX-CFH22AC25	Active Carbon / SPX-CFH22AC25
ACL Filter Standard Dimensions (H x W x D)	in. (mm)	(48x243x5)	(48x243x5)	(48x243x5)
ACL Filter Optional (Material - Accessory code)		-	-	-
Pre-filter Standard Material		STAINLESS	STAINLESS	STAINLESS
Pre-filter Optional (Material & Accessory code)		-	-	-

**NOTE:**

- Capacity and seasonal performance data (SEER /HSPF) are based on AHRI 210-240. The nominal heating and cooling capacity is the combined capacity of the HITACHI Split system (Indoor + Outdoor Unit).

Operation Conditions		Cooling	Heating
Indoor Air Inlet Temperature	dB	80 °F	70 °F
	WB	67 °F	
Outdoor Air Inlet Temperature	dB	95 °F	47 °F
	WB		43 °F
Piping Length: 7.5 meters; Piping Lift: 0 meter dB: Dry Bulb; WB: Wet Bulb			

- The Sound Pressure Level is based on the following conditions:

- 0.8 meter beneath indoor height center
- 1 meter from Discharge grille

The above data was measured in an anechoic chamber so that reflected sound should be taken into consideration when installing the unit.



**1.1.4. WALL TYPE (RAS-SH18RHLAE)**

INDOOR	Unit	RAS-SH18RHLAE
Nominal capacity adjustable		no
Nominal Cooling capacity (min - max)	BTU	18000(6600~20500)
Cooling sensible capacity	BTU	-
Nominal Heating capacity (min - max)	BTU	21500(7100~26000)
Noise level cooling (sound pressure) (SL / L / M / H)	dB(A)	35/42/45/49
Noise level heating (sound pressure) (SL / L / M / H)	dB(A)	35/42/45/49
Noise level (sound power) *match with Fiche/ Eurovent/Product Info	dB(A)	63
Air flow cooling mode (SL / L / M / H)	cfm (m³/h)	260/320/410/540
Air flow heating mode (SL / L / M / H)	cfm (m³/h)	270/330/420/570
Fan Motor	W	
Dehumidification	l/h	1.8
Included drain pump *for RAI/RAD	yes/no	no
Max. height available for drain pump (RAD/RAI only)	in. (mm)	no
Drain pump pressure lift *for RAI/RAD	in. (mm)	no
Static pressure switch at High(L / M / H) *for RAD	Pa (m3/h)	no
Dimensions (H x W x D)	in. (mm)	11.81x43.3x10.23 (300x1100x260)
Weight *must match with Packing data information	lbs. (kg)	37.5 (17)
Panel weight *for RAI	lbs. (kg)	-
Panel dimensions (H x W x D) *for RAI	in. (mm)	-
Colour (Munsell Code)		
Condensate Drain	in. (mm)	-
Panel reference		-
Color of the panel (RAL)		-
Running current (C/H) *for single split indoor&outdoor must be matched	A	-
Power supply	V	FROM OUTDOOR
Cable section (interconnection/*if power supply is connected to indoor)	mm²	0.8x 3+EARTH/-
Piping diameter (Liq / Gas)	Inch	1/4" / 1/2"
Drain diameter (ext)	in. (mm)	0.63(16)
Remote control (standard/optional) *	Standard	RAR-MOB6
	Optional	SPX-WKT4
<b>Filter</b>		
ACL Filter Standard (Material & Accessory code)		Active Carbon / SPX-CFH22AC25
ACL Filter Standard Dimensions (H x W x D)	in. (mm)	(48x243x5)
ACL Filter Optional (Material - Accessory code)		-
Pre-filter Standard Material		STAINLESS
Pre-filter Optional (Material & Accessory code)		-

**NOTE:**

- Capacity and seasonal performance data (SEER /HSPF) are based on AHRI 210-240. The nominal heating and cooling capacity is the combined capacity of the HITACHI Split system (Indoor + Outdoor Unit).

Operation Conditions		Cooling	Heating
Indoor Air Inlet Temperature	dB	80 °F	70 °F
	WB	67 °F	
Outdoor Air Inlet Temperature	dB	95 °F	47 °F
	WB		43 °F
Piping Length: 7.5 meters; Piping Lift: 0 meter dB: Dry Bulb; WB: Wet Bulb			

- The Sound Pressure Level is based on the following conditions:

- 0.8 meter beneath indoor height center
- 1 meter from Discharge grille

The above data was measured in an anechoic chamber so that reflected sound should be taken into consideration when installing the unit.



## 1.1.5. FLOOR TYPE (RAF-SH07QHLAE / SH09QHLAE / SH12QHLAE / SH18QHLAE)

INDOOR	Unit	RAF-SH07QHLAE	RAF-SH09QHLAE	RAF-SH12QHLAE	RAF-SH18QHLAE
Nominal capacity adjustable		no	no	no	no
Nominal Cooling capacity (min - max)	BTU	7000(3050-9000)	9000(3050-10600)	12000(3050-13650)	18000(3050-17750)
Cooling sensible capacity	BTU	-	-	-	-
Nominal Heating capacity (min - max)	BTU	9000(3050-10900)	11600(3050-15000)	15350(3050-18000)	20500(3050-27600)
Noise level cooling (sound pressure) (SL / L / M / H)	dB(A)	20/26/31/38	20/26/31/38	20/26/31/39	22/29/36/43
Noise level heating (sound pressure) (SL / L / M / H)	dB(A)	20/26/31/38	20/26/31/38	20/26/31/39	22/29/36/44
Noise level (sound power) *match with Fiche/ Eurovent/Product Info	dB(A)	52	52	53	57
Air flow cooling mode (SL / L / M / H)	cfm (m³/h)	159/230/300/371 (270/390/510/630)	159/230/300/371 (270/390/510/630)	159/230/300/371 (270/390/510/630)	177265/318/412 (300/450/540/700)
Air flow heating mode (SL / L / M / H)	cfm (m³/h)	177/247/318/388 (300/420/540/660)	177/247/318/388 (300/420/540/660)	177/247/318/388 (300/420/540/660)	194/283/335/430 (330/480/570/730)
Fan Motor	W	38	38	38	38
Dehumidification	l/h	1.2	1.4	1.9	2
Included drain pump *for RAI/RAD	yes/no	no	no	no	no
Max. height available for drain pump (RAD/RAI only)	in. (mm)	no	no	no	no
Drain pump pressure lift *for RAI/RAD	in. (mm)	no	no	no	no
Static pressure switch at High(L / M / H) *for RAD	Pa (m3/h)	no	no	no	no
Dimensions (H x W x D)	in. (mm)	23 x 30 x 8 ( 590 x 750 x 215 )	23 x 30 x 8 ( 590 x 750 x 215 )	23 x 30 x 8 ( 590 x 750 x 215 )	23 x 30 x 8 ( 590 x 750 x 215 )
Weight *must match with Packing data information	lbs. (kg)	33 ( 15 )	33 ( 15 )	33 ( 15 )	33 ( 15 )
Panel weight *for RAI	lbs. (kg)	-	-	-	-
Panel dimensions (H x W x D) *for RAI	in. (mm)	-	-	-	-
Colour (Munsell Code)		ShadowWhite (5PB8.7/0.5)	ShadowWhite (5PB8.7/0.5)	ShadowWhite (5PB8.7/0.5)	ShadowWhite (5PB8.7/0.5)
Condensate Drain	in. (mm)	0.63(16)	0.63(16)	0.63(16)	0.63(16)
Panel reference		-	-	-	-
Color of the panel (RAL)		-	-	-	-
Running current (C/H) *for single split indoor&outdoor must be matched	A	-	-	-	-
Power supply	V	FROM OUTDOOR	FROM OUTDOOR	FROM OUTDOOR	FROM OUTDOOR
Cable section (interconnection/*if power supply is connected to indoor)	mm²	0.8x 3+EARTH/-	0.8x 3+EARTH/-	0.8x 3+EARTH/-	0.8x 3+EARTH/-
Piping diameter (Liq / Gas)	Inch	1/4" / 3/8"	1/4" / 3/8"	1/4" / 3/8"	1/4" / 1/2"
Drain diameter (ext)	in. (mm)	0.63(16)	0.63(16)	0.63(16)	0.63(16)
Remote control (standard/optional) *	Standard	RAR-MOB3	RAR-MOB3	RAR-MOB3	RAR-MOB3
	Optional	SPX-RCDB1/ SPX-WKT4	SPX-RCDB1/ SPX-WKT4	SPX-RCDB1/ SPX-WKT4	SPX-RCDB1/ SPX-WKT4
<b>Filter</b>					
ACL Filter Standard (Material & Accessory code)		activated carbon / SPX-CFH22AC25	activated carbon / SPX-CFH22AC25	activated carbon / SPX-CFH22AC25	activated carbon / SPX-CFH22AC25
ACL Filter Standard Dimensions (H x W x D)	in. (mm)	48x243x5	48x243x5	48x243x5	48x243x5
ACL Filter Optional (Material - Accessory code)		-	-	-	-
Pre-filter Standard Material		STAINLESS	STAINLESS	STAINLESS	STAINLESS
Pre-filter Optional (Material & Accessory code)		-	-	-	-

**NOTE:**

- Capacity and seasonal performance data (SEER /HSPF) are based on AHRI 210-240. The nominal heating and cooling capacity is the combined capacity of the HITACHI Split system (Indoor + Outdoor Unit).

Operation Conditions		Cooling	Heating
Indoor Air Inlet Temperature	dB	80 °F	70 °F
	WB	67 °F	
Outdoor Air Inlet Temperature	dB	95 °F	47 °F
	WB		43 °F
Piping Length: 7.5 meters; Piping Lift: 0 meter dB: Dry Bulb; WB: Wet Bulb			

- The Sound Pressure Level is based on the following conditions:

- 0.8 meter beneath indoor height center
- 1 meter from Discharge grille

The above data was measured in an anechoic chamber. Please take into consideration reflected sound of your specific site



### 1.1.6. CEILING CASSETTE (RAI-SH07QHLAE / SH09QHLAE)

INDOOR	Unit	RAI-SH07QHLAE	RAI-SH09QHLAE
Nominal capacity adjustable		no	no
Nominal Cooling capacity (min - max)	BTU	7000(3050-8500)	9000(3050-10200)
Cooling sensible capacity	BTU	-	-
Nominal Heating capacity (min - max)	BTU	9000(3050-10900)	12000(3050-18000)
Noise level cooling (sound pressure) (SL / L / M / H)	dB(A)	27/31/35/38	27/31/35/38
Noise level heating (sound pressure) (SL / L / M / H)	dB(A)	28/32/36/39	28/32/36/39
Noise level (sound power) *match with Fiche/ Eurovent/Product Info	dB(A)	54	54
Air flow cooling mode (SL / L / M / H)	cfm (m³/h)	212/297/347/388 (360/505/590/660)	212/297/347/388 (360/505/590/660)
Air flow heating mode (SL / L / M / H)	cfm (m³/h)	261/318/371/424 444/540/630/720	261/318/371/424 444/540/630/720
Fan Motor	W	57	57
Dehumidification	l/h	1.2	1.4
Included drain pump *for RAI/RAD	yes/no	Yes	Yes
Max. height available for drain pump (RAD/RAI only)	in. (mm)	33(850)	33(850)
Drain pump pressure lift *for RAI/RAD	in. (mm)	4.5(115)	4.5(115)
Static pressure switch at High(L / M / H) *for RAD	Pa (m3/h)	no	no
Dimensions (H x W x D)	in. (mm)	11 x 22 x 22 (285 x 570 x 570)	11 x 22 x 22 (285 x 570 x 570)
Weight *must match with Packing data information	lbs. (kg)	37 (17)	37 (17)
Panel weight *for RAI	lbs. (kg)	6.17 (2.8)	6.17 (2.8)
Panel dimensions (H x W x D) *for RAI	in. (mm)	1.2 x 24.4 x 24.4 (30 x 620 x 620)	1.2 x 24.4 x 24.4 (30 x 620 x 620)
Colour (Munsell Code)		-	-
Condensate Drain	in. (mm)	1.26 (32)	1.26 (32)
Panel reference		-	-
Color of the panel (RAL)		-	-
Running current (C/H) *for single split indoor&outdoor must be matched	A	-	-
Power supply	V	FROM OUTDOOR	FROM OUTDOOR
Cable section (interconnection/*if power supply is connected to indoor)	mm²	0.8x 3+EARTH/-	0.8x 3+EARTH/-
Piping diameter (Liq / Gas)	Inch	1/4" / 3/8"	1/4" / 3/8"
Drain diameter (ext)	in. (mm)	1.26 (32)	1.26 (32)
Remote control (standard/optional) *	Standard	RAR-MOB3	RAR-MOB3
	Optional	SPX-RCDB1/SPX-WKT4	SPX-RCDB1/SPX-WKT4
<b>Filter</b>			
ACL Filter Standard (Material & Accessory code)		-	-
ACL Filter Standard Dimensions (H x W x D)	in. (mm)	-	-
ACL Filter Optional (Material - Accessory code)		-	-
Pre-filter Standard Material		NORMAL	NORMAL
Pre-filter Optional (Material & Accessory code)		-	-

2. The Sound Pressure Level is based on the following conditions:

- 1.5 meter beneath the unit

#### NOTE:

1. Capacity and seasonal performance data (SEER /HSPF) are based on AHRI 210-240. The nominal heating and cooling capacity is the combined capacity of the HITACHI Split system (Indoor + Outdoor Unit).

The above data was measured in an anechoic chamber so that reflected sound should be taken into consideration when installing the unit.

Operation Conditions		Cooling	Heating
Indoor Air Inlet Temperature	dB	80 °F	70 °F
	WB	67 °F	
Outdoor Air Inlet Temperature	dB	95 °F	47 °F
	WB		43 °F
Piping Length: 7.5 meters; Piping Lift: 0 meter dB: Dry Bulb; WB: Wet Bulb			



## 1.1.7. CEILING CASSETTE (RAI-SH12QHLAE / SH18QHLAE)

INDOOR	Unit	RAI-SH12QHLAE	RAI-SH18QHLAE
Nominal capacity adjustable		no	no
Nominal Cooling capacity (min - max)	BTU	12000(3050-13650)	18000(4100-19800)
Cooling sensible capacity	BTU	-	-
Nominal Heating capacity (min - max)	BTU	16400(3050-22500)	20500(4100-23200)
Noise level cooling (sound pressure) (SL / L / M / H)	dB(A)	29/35/39/43	29/35/39/43
Noise level heating (sound pressure) (SL / L / M / H)	dB(A)	30/36/40/44	30/36/40/44
Noise level (sound power) *match with Fiche/ Eurovent/Product Info	dB(A)	56	56
Air flow cooling mode (SL / L / M / H)	cfm (m³/h)	212/297/347/388 (360/505/590/660)	230/318/371/424 390/540/630/720
Air flow heating mode (SL / L / M / H)	cfm (m³/h)	261/318/371/424 444/540/630/720	265/353/406/459 450/600/690/780
Fan Motor	W	57	57
Dehumidification	l/h	1.4	2.8
Included drain pump *for RAI/RAD	yes/no	Yes	Yes
Max. height available for drain pump (RAD/RAI only)	in. (mm)	33(850)	33(850)
Drain pump pressure lift *for RAI/RAD	in. (mm)	<b>4.5(115)</b>	<b>4.5(115)</b>
Static pressure switch at High(L / M / H) *for RAD	Pa (m3/h)	no	no
Dimensions (H x W x D)	in. (mm)	11 x 22 x 22 (285 x 570 x 570)	11 x 22 x 22 (285 x 570 x 570)
Weight *must match with Packing data information	lbs. (kg)	37 (17)	37 (17)
Panel weight *for RAI	lbs. (kg)	6.17 (2.8)	6.17 (2.8)
Panel dimensions (H x W x D) *for RAI	in. (mm)	1.2 x 24.4 x 24.4 (30 x 620 x 620)	1.2 x 24.4 x 24.4 (30 x 620 x 620)
Colour (Munsell Code)		-	-
Condensate Drain	in. (mm)	1.26 (32)	1.26 (32)
Panel reference		-	-
Color of the panel (RAL)		-	-
Running current (C/H) *for single split indoor&outdoor must be matched	A	-	-
Power supply	V	FROM OUTDOOR	FROM OUTDOOR
Cable section (interconnection/*if power supply is connected to indoor)	mm²	0.8x 3+EARTH/-	0.8x 3+EARTH/-
Piping diameter (Liq / Gas)	Inch	1/4" / 3/8"	1/4" / 1/2"
Drain diameter (ext)	in. (mm)	1.26 (32)	1.26 (32)
Remote control (standard/optional) *	Standard	RAR-MOB3	RAR-MOB3
	Optional	SPX-RCDB1/SPX-WKT4	SPX-RCDB1/SPX-WKT4
<b>Filter</b>			
ACL Filter Standard (Material & Accessory code)		-	-
ACL Filter Standard Dimensions (H x W x D)	in. (mm)	-	-
ACL Filter Optional (Material - Accessory code)		-	-
Pre-filter Standard Material		NORMAL	NORMAL
Pre-filter Optional (Material & Accessory code)		-	-

2. The Sound Pressure Level is based on the following conditions:

- 1.5 meter beneath the unit

**NOTE:**

1. Capacity and seasonal performance data (SEER /HSPF) are based on AHRI 210-240. The nominal heating and cooling capacity is the combined capacity of the HITACHI Split system (Indoor + Outdoor Unit).

The above data was measured in an anechoic chamber so that reflected sound should be taken into consideration when installing the unit.

Operation Conditions		Cooling	Heating
Indoor Air Inlet Temperature	dB	80 °F	70 °F
	WB	67 °F	
Outdoor Air Inlet Temperature	dB	95 °F	47 °F
	WB		43 °F
Piping Length: 7.5 meters; Piping Lift: 0 meter dB: Dry Bulb; WB: Wet Bulb			



**1.1.8. DUCT TYPE (RAD-SH07QHLAE / SH09QHLAE / SH12QHLAE)**

INDOOR	Unit	RAD-SH07QHLAE	RAD-SH09QHLAE	RAD-SH12QHLAE
Nominal capacity adjustable		no	no	no
Nominal Cooling capacity (min - max)	BTU	7000(3050-8500)	9000(3050-10200)	12000(3050-13650)
Cooling sensible capacity	BTU	-	-	-
Nominal Heating capacity (min - max)	BTU	9000(3050-10900)	12000(3050-18000)	16400(3050-22500)
Noise level cooling (sound pressure) (SL / L / M / H)	dB(A)	30/33/37/41	30/33/37/41	30/33/37/41
Noise level heating (sound pressure) (SL / L / M / H)	dB(A)	30/34/38/42	30/34/38/42	30/34/38/42
Noise level (sound power) *match with Fiche/ Eurovent/Product Info	dB(A)	57	57	57
Air flow cooling mode (SL / L / M / H)	cfm (m³/h)	194/229/264/300 (330/390/450/510)	194/229/264/300 (330/390/450/510)	194/229/264/300 (330/390/450/510)
Air flow heating mode (SL / L / M / H)	cfm (m³/h)	194/229/264/300 (330/390/450/510)	194/229/264/300 (330/390/450/510)	194/229/264/300 (330/390/450/510)
Fan Motor	W	20	20	20
Dehumidification	l/h	1.4	1.4	1.6
Included drain pump *for RAI/RAD	yes/no	yes	yes	yes
Max. height available for drain pump (RAD/RAI only)	in. (mm)	33(850)	33(850)	33(850)
Drain pump pressure lift *for RAI/RAD	in. (mm)	<b>4.5(115)</b>	<b>4.5(115)</b>	<b>4.5(115)</b>
Static pressure switch at High(L / M / H) *for RAD	Pa (m3/h)	70	70	70
Dimensions (H x W x D)	in. (mm)	9x29x15 (235x750x400)	9x29x15 (235x750x400)	9x29x15 (235x750x400)
Weight *must match with Packing data information	lbs. (kg)	35 (16)	35 (16)	35 (16)
Panel weight *for RAI	lbs. (kg)	-	-	-
Panel dimensions (H x W x D) *for RAI	in. (mm)	-	-	-
Colour (Munsell Code)		-	-	-
Condensate Drain	in. (mm)	0.63(16)	0.63(16)	0.63(16)
Panel reference		-	-	-
Color of the panel (RAL)		-	-	-
Running current (C/H) *for single split indoor&outdoor must be matched	A	-	-	-
Power supply	V	FROM OUTDOOR	FROM OUTDOOR	FROM OUTDOOR
Cable section (interconnection/*if power supply is connected to indoor)	mm²	0.8x 3+EARTH/-	0.8x 3+EARTH/-	0.8x 3+EARTH/-
Piping diameter (Liq / Gas)	Inch	1/4", 3/8"	1/4", 3/8"	1/4", 3/8"
Drain diameter (ext)	in. (mm)	0.63 (16)	0.63 (16)	0.63 (16)
Remote control (standard/optional) *	Standard	SPX-RCDA1/SPX-WKT4	SPX-RCDA1/SPX-WKT4	SPX-RCDA1/SPX-WKT4
	Optional	RAR-MOB4	RAR-MOB4	RAR-MOB4
<b>Filter</b>				
ACL Filter Standard (Material & Accessory code)		-	-	-
ACL Filter Standard Dimensions (H x W x D)	in. (mm)	-	-	-
ACL Filter Optional (Material - Accessory code)		-	-	-
Pre-filter Standard Material		NORMAL	NORMAL	NORMAL
Pre-filter Optional (Material & Accessory code)		-	-	-

**NOTE:**

- Capacity and seasonal performance data (SEER /HSPF) are based on AHRI 210-240. The nominal heating and cooling capacity is the combined capacity of the HITACHI Split system (Indoor + Outdoor Unit).

Operation Conditions		Cooling	Heating
Indoor Air Inlet Temperature	dB	80 °F	70 °F
	WB	67 °F	
Outdoor Air Inlet Temperature	dB	95 °F	47 °F
	WB		43 °F
Piping Length: 7.5 meters; Piping Lift: 0 meter dB: Dry Bulb; WB: Wet Bulb			

2. The Sound Pressure Level is based on the following conditions:

- 1.5 meter beneath the unit

The above data was measured in an anechoic chamber. Please take into consideration reflected sound of your specific site



## 1.1.9. DUCT TYPE (RAD-SH18QHLAE)

INDOOR	Unit	RAD-SH18QHLAE
Nominal capacity adjustable		no
Nominal Cooling capacity (min - max)	BTU	18000(4100-19800)
Cooling sensible capacity	BTU	-
Nominal Heating capacity (min - max)	BTU	20500(4100-23200)
Noise level cooling (sound pressure) (SL / L / M / H)	dB(A)	29/32/35/39
Noise level heating (sound pressure) (SL / L / M / H)	dB(A)	29/32/35/40
Noise level (sound power) *match with Fiche/ Eurovent/Product Info	dB(A)	53
Air flow cooling mode (SL / L / M / H)	cfm (m³/h)	206/317/470/671 (350/540/800/1140)
Air flow heating mode (SL / L / M / H)	cfm (m³/h)	206/317/470/671 (350/540/800/1140)
Fan Motor	W	180
Dehumidification	l/h	2.8
Included drain pump *for RAI/RAD	yes/no	yes
Max. height available for drain pump (RAD/RAI only)	in. (mm)	33(850)
Drain pump pressure lift *for RAI/RAD	in. (mm)	<b>4.5(115)</b>
Static pressure switch at High(L / M / H) *for RAD	Pa (m3/h)	50/100150
Dimensions (H x W x D)	in. (mm)	10x35x28 (270x900x700)
Weight *must match with Packing data information	lbs. (kg)	77 (35)
Panel weight *for RAI	lbs. (kg)	-
Panel dimensions (H x W x D) *for RAI	in. (mm)	-
Colour (Munsell Code)		-
Condensate Drain	in. (mm)	1.26 (32)
Panel reference		-
Color of the panel (RAL)		-
Running current (C/H) *for single split indoor&outdoor must be matched	A	-
Power supply	V	FROM OUTDOOR
Cable section (interconnection/*if power supply is connected to indoor)	mm²	0.8x 3+EARTH/-
Piping diameter (Liq / Gas)	Inch	1/4", 1/2"
Drain diameter (ext)	in. (mm)	1.26 (32)
Remote control (standard/optional) *	Standard	SPX-RCDA1/SPX-WKT4
	Optional	RAR-MOB4
<b>Filter</b>		
ACL Filter Standard (Material & Accessory code)		-
ACL Filter Standard Dimensions (H x W x D)	in. (mm)	-
ACL Filter Optional (Material - Accessory code)		-
Pre-filter Standard Material		NORMAL
Pre-filter Optional (Material & Accessory code)		-

2. The Sound Pressure Level is based on the following conditions:

- 1.5 meter beneath the unit

**NOTE:**

1. Capacity and seasonal performance data (SEER /HSPF) are based on AHRI 210-240. The nominal heating and cooling capacity is the combined capacity of the HITACHI Split system (Indoor + Outdoor Unit).

The above data was measured in an anechoic chamber. Please take into consideration reflected sound of your specific site

Operation Conditions		Cooling	Heating
Indoor Air Inlet Temperature	dB	80 °F	70 °F
	WB	67 °F	
Outdoor Air Inlet Temperature	dB	95 °F	47 °F
	WB		43 °F
Piping Length: 7.5 meters; Piping Lift: 0 meter dB: Dry Bulb; WB: Wet Bulb			



## 1.1.10. DUCT STATIC PRESSURE AND AIR FLOW (RAD-SH07/09/12QHLAE)

RAD-SH07QHLAE  
RAD-SH09QHLAE  
RAD-SH12QHLAE

## Fan Mode

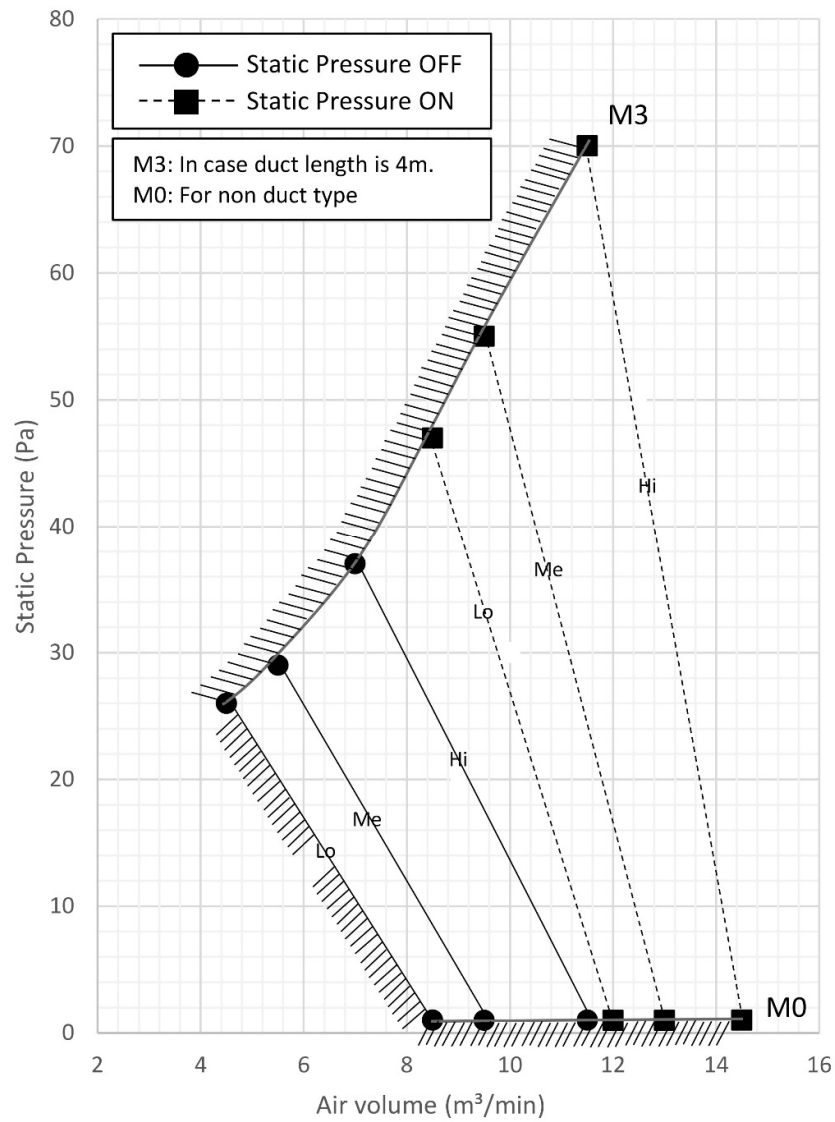



1.1.11. DUCT STATIC PRESSURE AND AIR FLOW (RAD-SH18QHLAE)

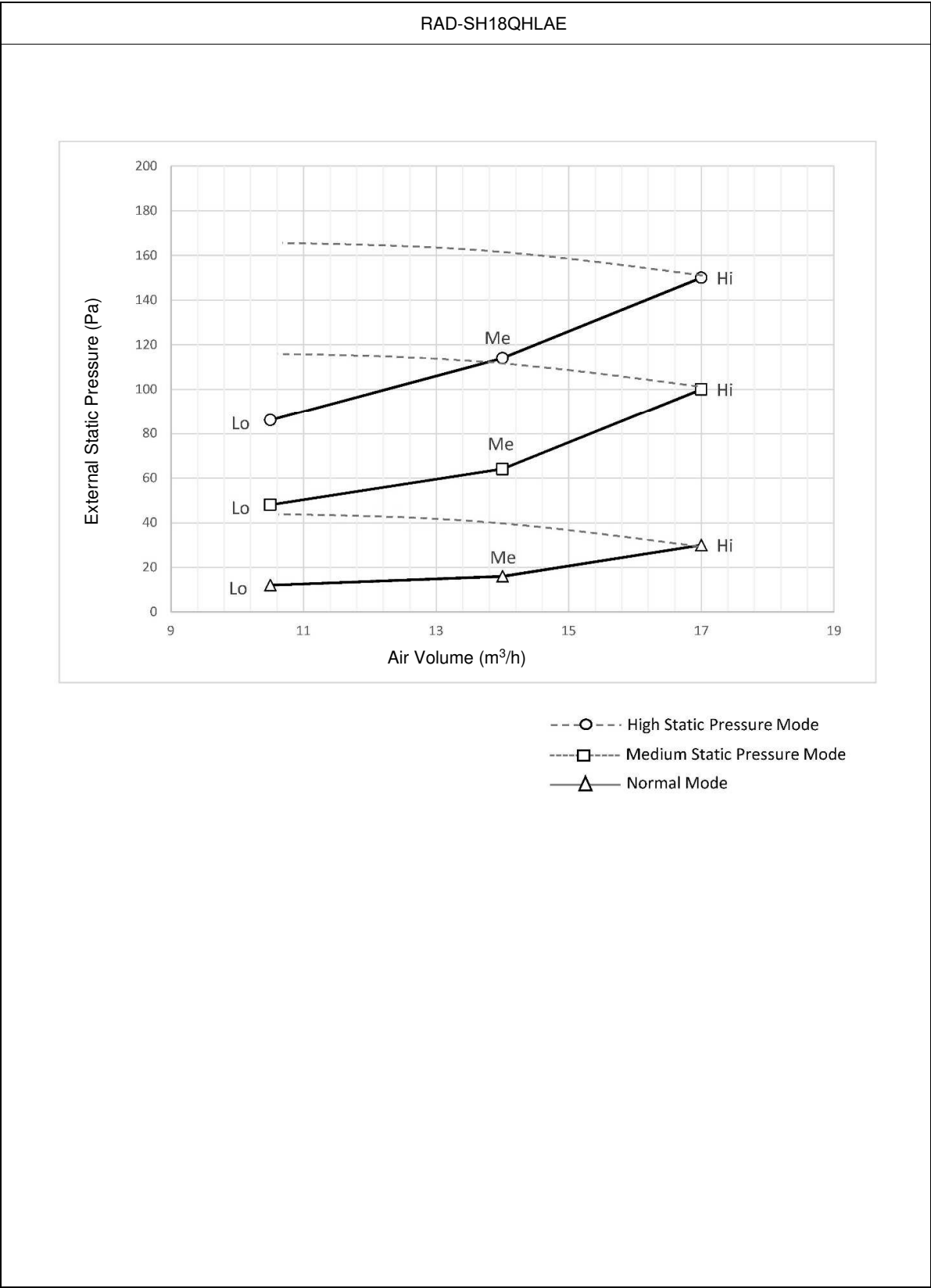



## 1.2. RAM-S24U3HLAE

OUTDOOR	UNIT	RAM-S24U3HLAE
Minimum / Maximum indoor units connectable (for MULTI only)		2 / 3
Minimum / Maximum connected indoor capacity (for MULTI only)	kBTU	14/ 36
Nominal Cooling capacity (min - max) *for single split indoor&outdoor must be matched	BTU	24000(7000~28800)
Nominal Heating capacity (min - max) *for single split indoor&outdoor must be matched	BTU	28000 (9000-32000)
Nominal cooling power input (min - max)	kW	1.92 ( 0.46 - 3.70)
Nominal heating power input (min - max)	kW	2.48 ( 0.46 - 2.90)
EER(T1condition)	Btu/W	12.5
COP (H1 condition)	Btu/W	11.3
SEER / SCOP *average climate		20.0/10.5
Noise level cooling (sound pressure)	dB(A)	52
Noise level heating (sound pressure)	dB(A)	54
Noise level - ODU (sound power)	dB(A)	66
Air flow (Cooling / Heating)	cfm (m³/h)	1589(2700)/1589(2700)
Dimensions (H x W x D)	in. (mm)	31x33x12(800x850x298)
Net weight	lbs. (kg)	121(55)
Colour (Munsell Code)		Beige (5Y7/2)
Power supply	V/Ph/Hz	208- 230V / 1Ph / 60Hz
Recommended fuse size	A	20
Starting current(rated current of COOL/HEAT whichever higher for inverter)	A	9.28/11.97
Running current (C/H) *for single split indoor&outdoor must be matched	A	8.39/10.83
Cable section (power)	mm²	2.50x 2+EARTH
Interconnection between indoor unit and outdoor unit	mm²	0.80x 3+EARTH
Piping diameter (Liq / Gas) *for single split indoor&outdoor must be matched	Inch	(1/4" / 3/8")X3
Minimum piping length	ft. (m)	16(5)
Maximum piping length / height difference	ft. (m)	197(60)/66(20)
Current quantity of refrigerant / Chargeless	lbs. (kg)	5.51(2500)
Chargeless length / Additional refrigerant charge	m / g/m	30 / 12
Working range (cooling / heating)	°F( °C)	14 to 115 (-10 to +46)
	°F( °C)	-4 to 75 (-20 to +24)
Refrigerant		R410A
Condenser Fan		Propeller Fan
Compressor	Type	2 Cylinder Rotary
	Oil Type	α68HES-H or equivalent
	Oil Charge l	770 ± 20
	Coil resistance	1.354Ω at 20°C
	Quantity	1

**NOTE:**

1. The Sound Pressure Level is based on the following conditions:

- Half height of the unit
- 1 meter from Discharge grille

The above data was measured in an anechoic chamber. Please take into consideration reflected sound of your specific site



## 2 DIMENSIONAL DATA

### CONTENTS

<b>2</b>	<b>DIMENSIONAL DATA</b>	<b>2-1</b>
2.1.	MULTIZONE INDOOR UNITS	2-2
2.1.1.	WALL TYPE (RAS-EH07QHLAE, RAS-EH09/12/18RHLAE)	2-2
2.1.2.	WALL TYPE (RAS-SH18RHLAE)	2-3
2.1.3.	WALL TYPE (RAS-SH07QHLAE, RAS-SH09/12RHLAE)	2-4
2.1.4.	FLOOR TYPE (RAF-SH07/09/12/18/QHLAE)	2-5
2.1.5.	CEILING CASSETTE (RAI- SH07/09/12/18QHLAE)	2-6
2.1.6.	DUCT TYPE (RAD-SH07/09/12QHLAE)	2-7
2.1.7.	DUCT TYPE (RAD-SH18QHLAE)	2-8
2.2.	MULTIZONE OUTDOOR UNITS (RAM-S24U3HLAE)	2-9



## 2.1. MULTIZONE INDOOR UNITS

### 2.1.1. WALL TYPE: RAS-EH07QHLAE / EH09RHLAE / EH12RHLAE / EH18RHLAE

Unit: mm

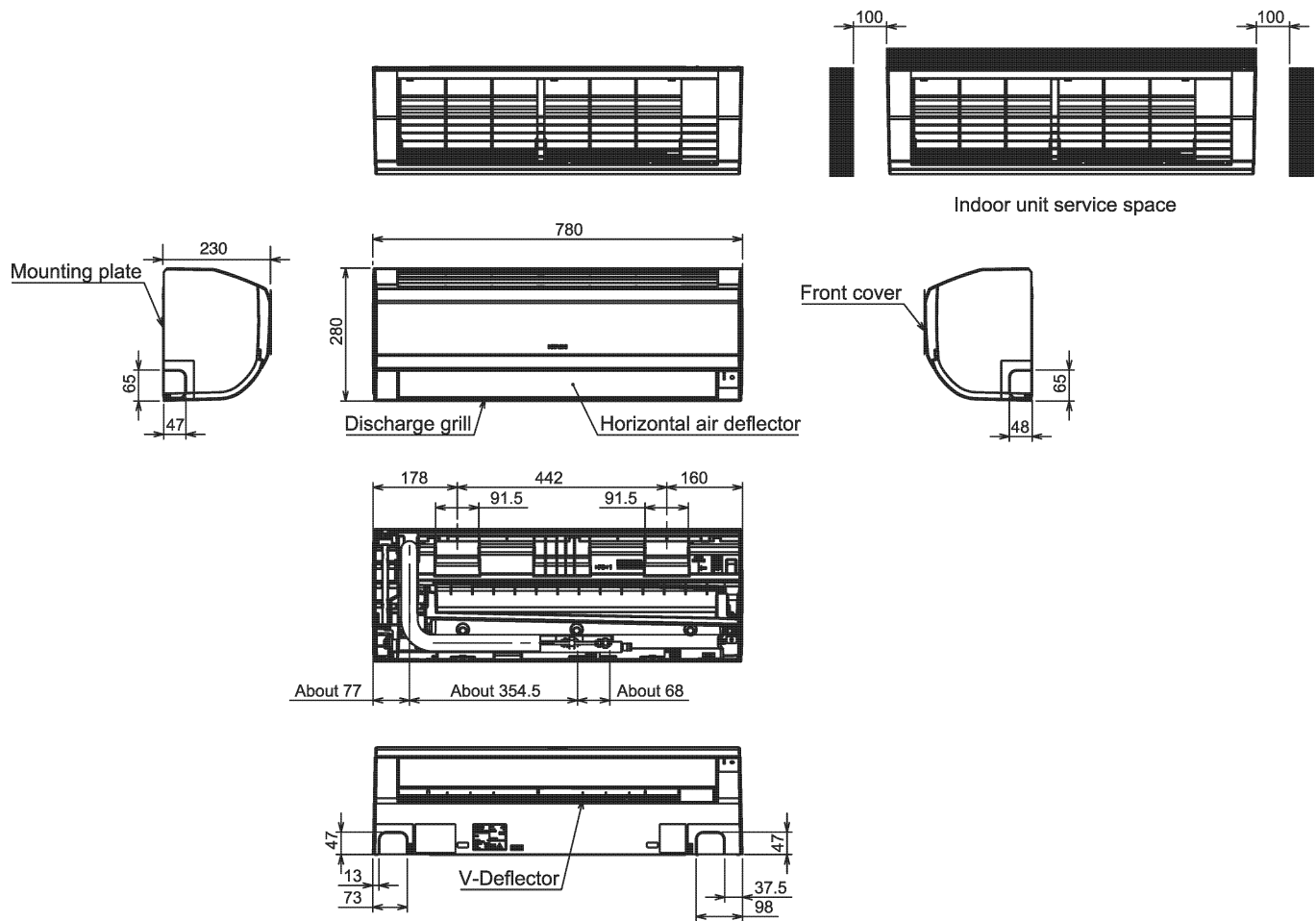



2.1.2. WALL TYPE: RAS-SH07QHLAE / SH09RHLAE / SH12RHLAE

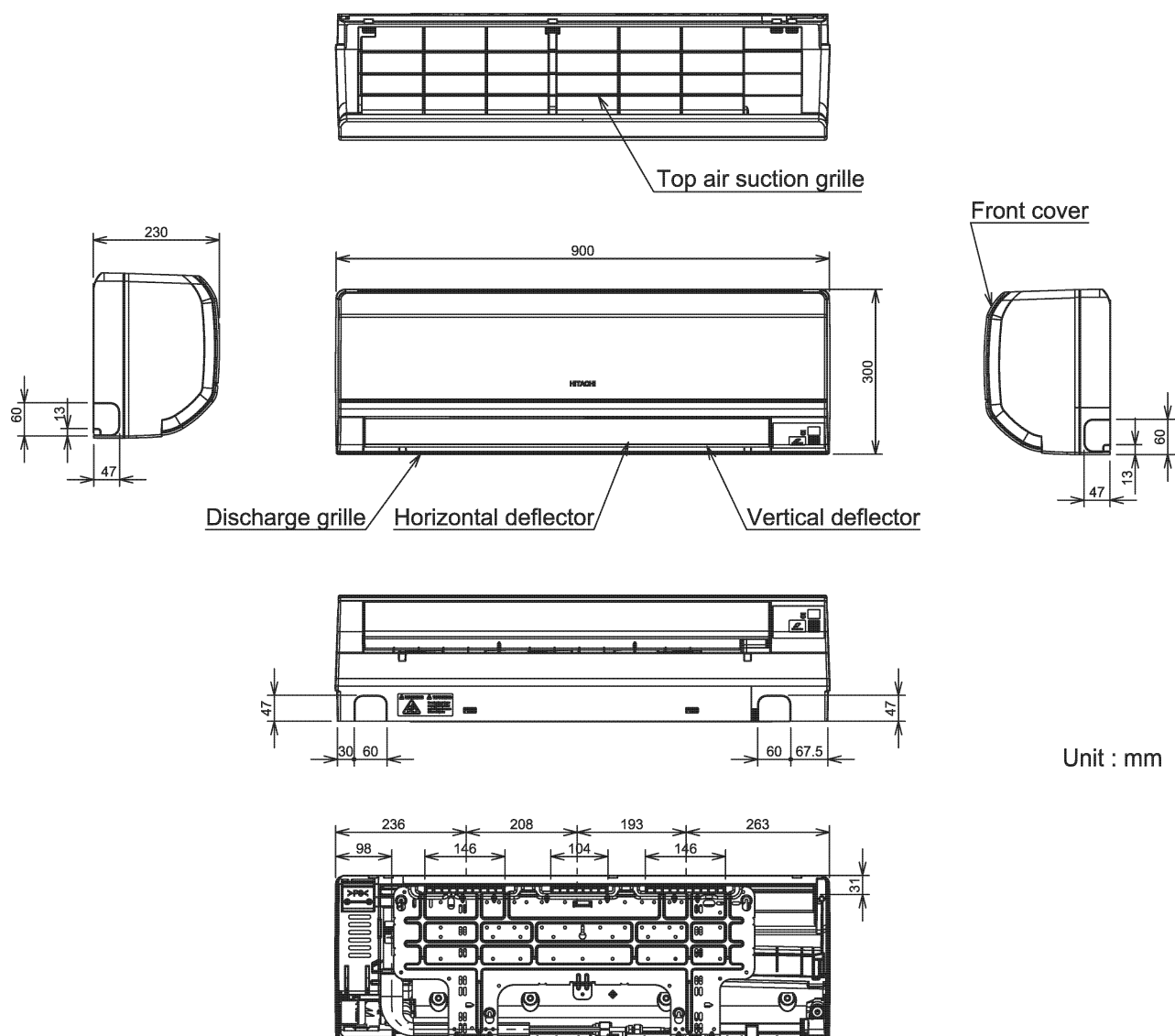



2.1.3. WALL TYPE: RAS-SH18HLAE

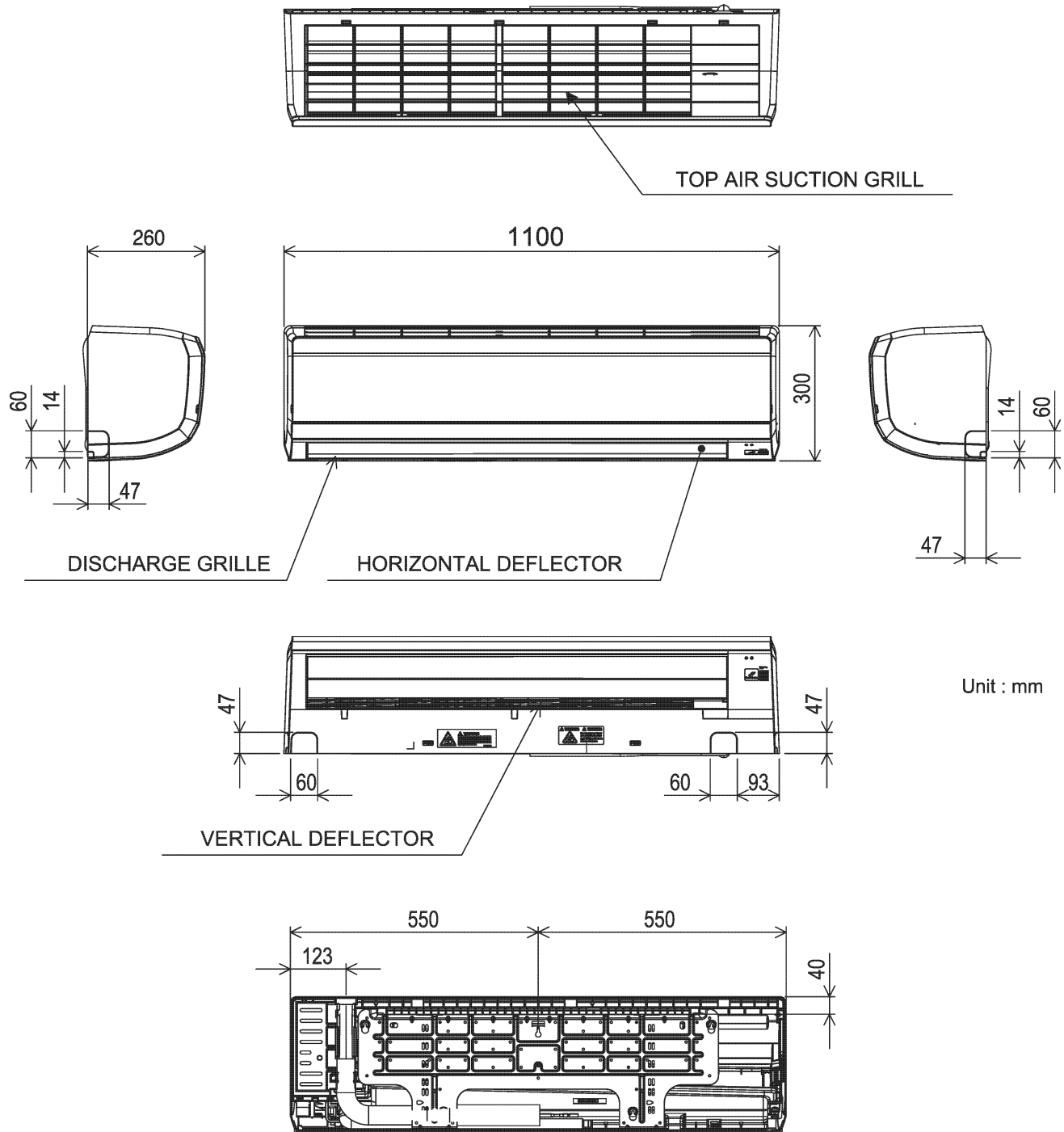







2.1.5. CEILING CASSETTE TYPE: RAI-SH07QHLAE / SH09QHLAE / SH12QHLAE / SH18QHLAE

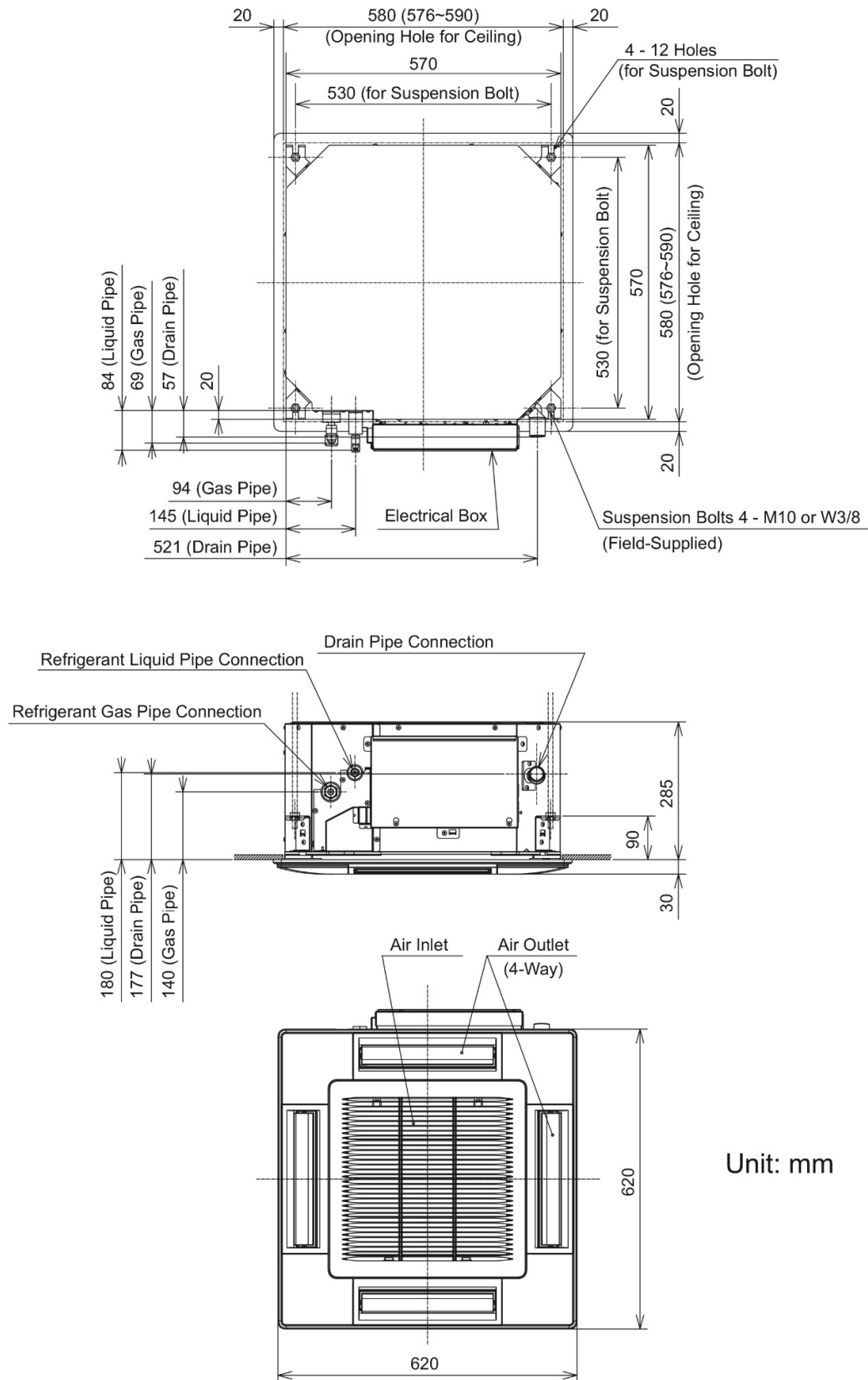



2.1.6. DUCT TYPE: RAD-SH07QHLAE / SH09QHLAE / SH12QHLAE

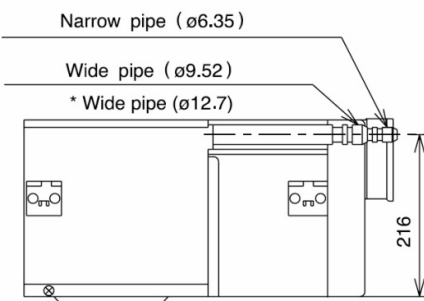
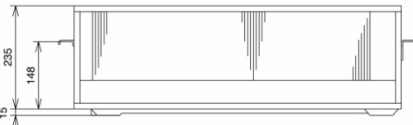
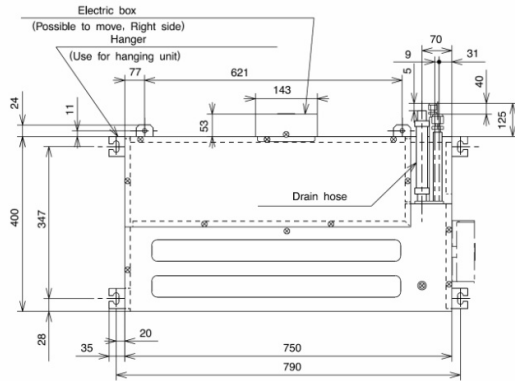

Unit: mm

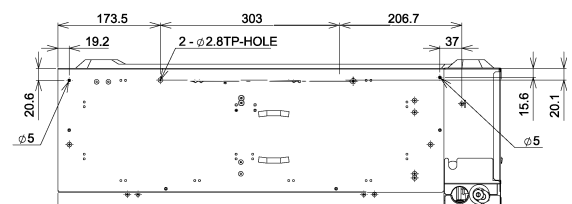
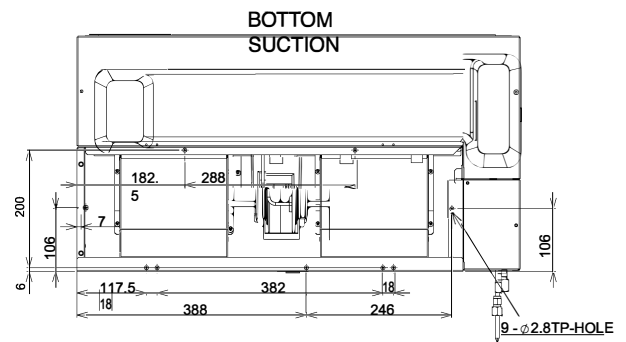
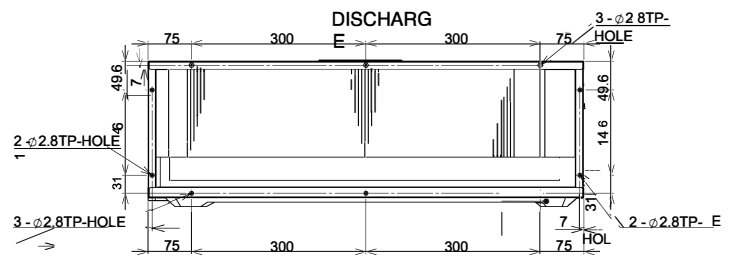
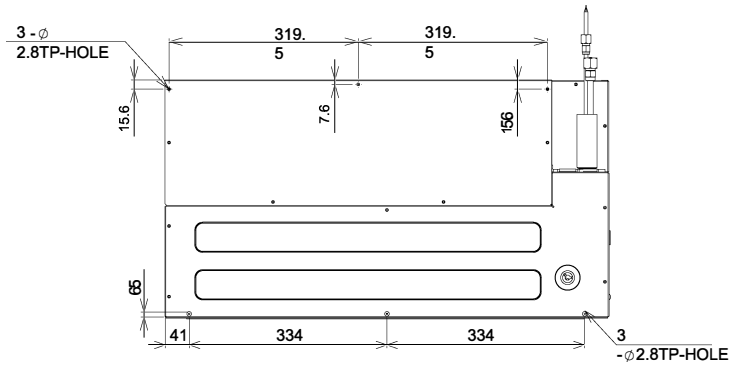
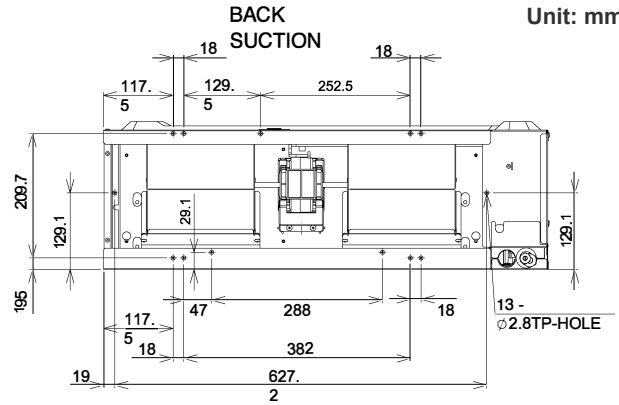



## 2.1.7. DUCT TYPE: RAD-SH18QHLAE

Unit: mm

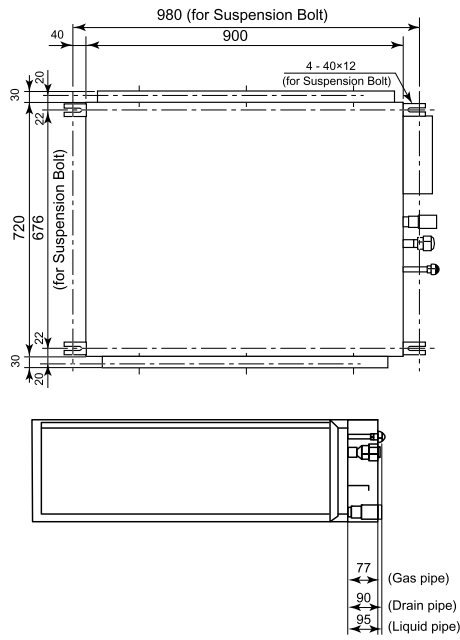

SIDE VIEW

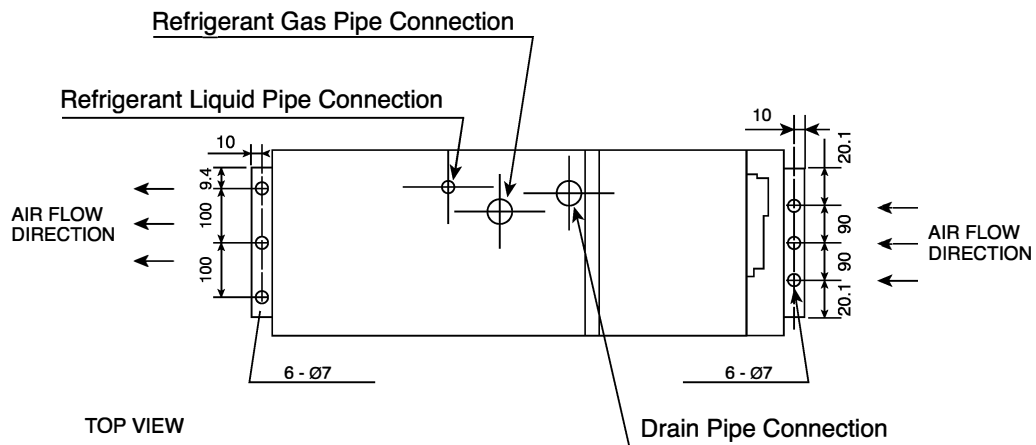
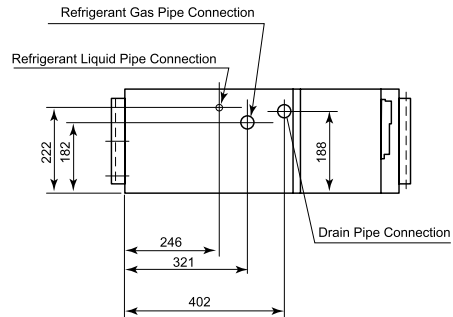

TOP VIEW

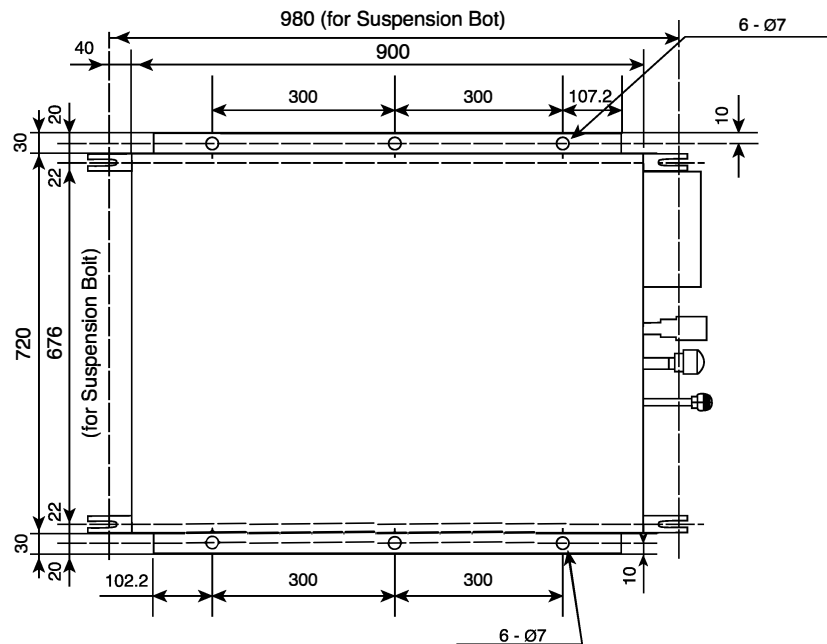



## 2.2 3 ROOMS MULTIZONE: RAM-S24U3HLAE

Unit: mm

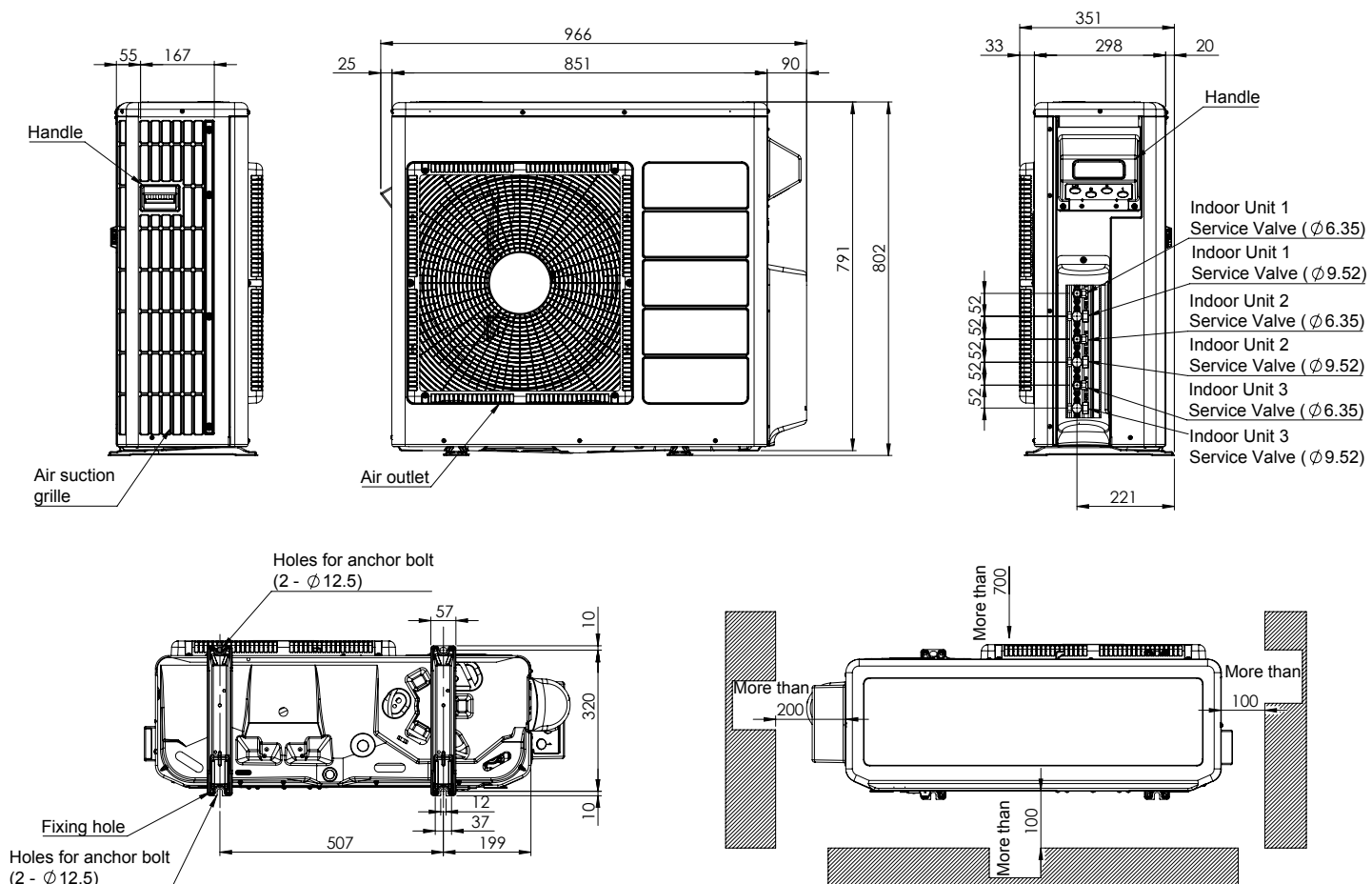



### 3 CAPACITIES AND SELECTION DATA

#### CONTENTS

<b>3</b>	<b>CAPACITIES AND SELECTION DATA</b>	<b>3-1</b>
3.1.	SYSTEM SELECTION PROCEDURE	3-2
3.1.1.	SELECTION UNIT FEATURES	3-2
3.1.2.	SELECTION GUIDE	3-2
3.2.	CAPACITY CHARACTERISTIC CURVES FOR MULTIZONE	3-3
3.3.	CORRECTION FACTORS ACCORDING TO PIPING LENGTH	3-8
3.4.	CORRECTION FACTORS ACCORDING TO DEFROSTING OPERATION	3-10
3.5.	COMBINATION TABLE FOR MULTIZONE OUTDOOR	3-11



### 3.1. SYSTEM SELECTION PROCEDURE

The following system procedure is giving a sample regarding unit selection system, indicating how to use all parameters showed in this chapter.

#### 3.1.1. SELECTION UNIT FEATURES

Considering the building distribution, the possible indoor unit position and the available air flow distribution, select the unit features that are giving the best efficiency and comfort to each room.

Decide the Outdoor Unit position getting easy service maintenance and easy refrigerant pipe installation.

Therefore, the maximum indoor unit capacity combined with outdoor unit should be carefully considered for correct indoor unit distribution at each building

#### 3.1.2. SELECTION GUIDE

The following guide giving the method for indoor and outdoor unit selection.

##### \* Step 1: Determine the system requirements

Calculate the cooling capacity and heating capacity of each indoor unit according to the following conditions:

Total Load for each room

		Room			
Item		1	2	3	1+2+3
Estimated Cooling Load	kW	2.75	4.24	5.35	12.34
Estimated Heating Load	kW	2.90	4.60	6.00	13.50

\*Example

Temperature Condition

Cooling	Heating
Outdoor Air Inlet • Dry Bulb: 95°F	Outdoor Air Inlet • Dry Bulb: 47°F • Wet Bulb: 43°F
Indoor Air Inlet • Dry Bulb: 80°F • Wet Bulb: 67°F	Indoor Air Inlet • Dry Bulb: 70°F

\*Example

##### \* Step 2: Select Unit Capacity Performance

The unit kW is selected following the Cooling capacity and Heating capacity showed in the combination table.

##### \* Step 3: Read Selected Capacity Performance

The unit performance should be calculated considering the following correction factors:

1. Cooling and Heating piping length
2. Outdoor unit performance capacity
3. Indoor unit performance capacity for each room cooling load

Kindly refer to the unit selection combination table for correct capacity performance.



### 3.2. CAPACITY CHARACTERISTIC CURVES FOR MULTIZONE

The following charts show the characteristics of outdoor unit capacity, which corresponds with the operating ambient temperature of outdoor unit.

Conditions:

· Pipe length / height difference : 7.5m / 0m

③Capacity loss due to white frost and defrost operation is not included.

· Indoor fan speed at High mode

#### RAM-S24U3HLAE

### COOLING [60Hz, 230V]

COOLING	INDOOR		OUTDOOR TEMPERATURE ("FDW)																				
	EWB	EDB	14			70			81			90			95			104			109		
	"F	"F	TC	SHC	PI	TC	SHC	PI	TC	SHC	PI	TC	SHC	PI	TC	SHC	PI	TC	SHC	PI	TC	SHC	PI
RAM-S24U3HLAE	54	64	19920	18252	1143	22560	24336	1357	20880	22464	1599	19680	21294	1766	18960	20358	1843	17760	19188	1978	17040	18252	2054
	57	68	19920	18252	1143	24240	24336	1357	22560	22698	1618	21120	21294	1786	20400	20592	1862	18960	19188	1997	18240	18486	2093
	61	72	19920	19422	1161	25920	24336	1375	24000	22698	1637	22560	21294	1805	21840	20592	1901	20400	19188	2035	19680	18486	2112
	64	77	21360	20826	1178	27600	26442	1393	25440	24570	1656	24000	23166	1824	23040	22230	1901	21600	20826	2054	20640	19890	2131
	66	81	22080	21528	1196	28560	27846	1411	26400	25740	1675	24960	24336	1843	24000	23400	1920	22560	21996	2054	21600	21060	2131
	72	86	24480	21294	1196	31680	27612	1411	29280	25506	1675	27600	24102	1862	26640	23166	1939	24000	22464	2131	22320	21996	2246
	75	90	26160	21294	1214	33840	27612	1428	31200	25506	1693	29520	24102	1862	28320	23166	1958	24960	22932	2189	22800	22698	2323
7K	54	64	5810	5324	268	6580	7098	318	6090	6552	375	5740	6211	414	5530	5938	432	5180	5597	464	4970	5324	482
	57	68	5810	5324	268	7070	7098	318	6580	6620	379	6160	6211	419	5950	6006	437	5530	5597	468	5320	5392	491
	61	72	5810	5665	272	7560	7098	322	7000	6620	384	6580	6211	423	6370	6006	446	5950	5597	477	5740	5392	495
	64	77	6230	6074	276	8050	7712	326	7420	7166	388	7000	6757	428	6720	6484	446	6300	6074	482	6020	5801	500
	66	81	6440	6279	280	8330	8122	331	7700	7508	392	7280	7098	432	7000	6825	450	6580	6416	482	6300	6143	500
	72	86	7140	6211	280	9240	8054	331	8540	7439	392	8050	7030	437	7770	6757	455	7000	6552	500	6510	6416	527
	75	90	7630	6211	285	9870	8054	335	9100	7439	397	8610	7030	437	8260	6757	459	7280	6689	513	6650	6620	545
9K	54	64	7470	6845	387	8460	9126	459	7830	8424	541	7380	7985	598	7110	7634	624	6660	7196	670	6390	6845	696
	57	68	7470	6845	387	9090	9126	459	8460	8512	548	7920	7985	605	7650	7722	631	7110	7196	676	6840	6932	709
	61	72	7470	7283	393	9720	9126	465	9000	8512	554	8460	7985	611	8190	7722	644	7650	7196	689	7380	6932	715
	64	77	8010	7810	399	10350	9916	472	9540	9214	561	9000	8687	618	8640	8336	644	8100	7810	696	7740	7459	722
	66	81	8280	8073	405	10710	10442	478	9900	9653	567	9360	9126	624	9000	8775	650	8460	8249	696	8100	7898	722
	72	86	9180	7985	405	11880	10355	478	10980	9565	567	10350	9038	631	9990	8687	657	9000	8424	722	8370	8249	761
	75	90	9810	7985	411	12690	10355	484	11700	9565	573	11070	9038	631	10620	8687	663	9360	8600	741	8550	8512	787
12K	54	64	9960	9126	613	11280	12168	728	10440	11232	858	9840	10647	948	9480	10179	989	8880	9594	1061	8520	9126	1102
	57	68	9960	9126	613	12120	12168	728	11280	11349	868	10560	10647	958	10200	10296	999	9480	9594	1071	9120	9243	1123
	61	72	9960	9711	623	12960	12168	738	12000	11349	878	11280	10647	968	10920	10296	1020	10200	9594	1092	9840	9243	1133
	64	77	10680	10413	632	13800	13221	747	12720	12285	888	12000	11583	979	11520	11115	1020	10800	10413	1102	10320	9945	1143
	66	81	11040	10764	642	14280	13923	757	13200	12870	898	12480	12168	989	12000	11700	1030	11280	10998	1102	10800	10530	1143
	72	86	12240	10647	642	15840	13806	757	14640	12753	898	13800	12051	999	13320	11583	1040	12000	11232	1143	11160	10998	1205
	75	90	13080	10647	651	16920	13806	766	15600	12753	908	14760	12051	999	14160	11583	1051	12480	11466	1174	11400	11349	1246
18K	54	64	14940	13689	952	16920	18252	1131	15660	16848	1333	14760	15971	1472	14220	15269	1536	13320	14391	1648	12780	13689	1712
	57	68	14940	13689	952	18180	18252	1131	16920	17024	1348	15840	15971	1488	15300	15444	1552	14220	14391	1664	13680	13865	1744
	61	72	14940	14567	967	19440	18252	1146	18000	17024	1364	16920	15971	1504	16380	15444	1584	15300	14391	1696	14760	13865	1760
	64	77	16020	15620	982	20700	19832	1161	19080	18428	1380	18000	17375	1520	17280	16673	1584	16200	15620	1712	15480	14918	1776
	66	81	16560	16146	997	21420	20885	1176	19800	19305	1396	18720	18252	1536	18000	17550	1600	16920	16497	1712	16200	15795	1776
	72	86	18360	15971	997	23760	20709	1176	21960	19130	1396	20700	18077	1552	19980	17375	1616	18000	16848	1776	16740	16497	1872
	75	90	19620	15971	1012	25380	20709	1190	23400	19130	1411	22140	18077	1552	21240	17375	1632	18720	17199	1824	17100	17024	1936
7K+7K	54	64	11620	10647	744	13160	14196	884	12180	13104	1041	11480	12422	1150	11060	11876	1200	10360	11193	1288	9940	10647	1338
	57	68	11620	10647	744	14140	14196	884	13160	13241	1054	12320	12422	1163	11900	12012	1213	11060	11193	1300	10640	10784	1363
	61	72	11620	11330	756	15120	14196	895	14000	13241	1066	13160	12422	1175	12740	12012	1238	11900	11193	1325	11480	10784	1375
	64	77	12460	12149	767	16100	15425	907	14840	14333	1078	14000	13514	1188	13440	12968	1238	12600	12149	1338	12040	11603	1388
	66	81	12880	12558	779	16660	16244	918	15400	15015	1090	14560	14196	1200	14000	13650	1250	13160	12831	1338	12600	12285	1388
	72	86	14280	12422	779	18480	16107	918	17080	14879	1090	16100	14060	1213	15540	13514	1263	14000	13104	1388	13020	12831	1463
	75	90	15260	12422	791	19740	16107	930	18200	14879	1103	17220	14060	1213	16520	13514	1275	14560	13377	1425	13300	13241	1513
7K+9K	54	64	13280	12168	863	15040	16224	1025	13920	14976	1208	13120	14196	1334	12640	13572	1392	11840	12792	1494	11360	12168	1552
	57	68	13280	12168	863	16160	16224	1025	15040	15132	1222	14080	14196	1349	13600	13728	1407	12640	12792	1508	12160	12324	1581
	61	72	13280	12948	877	17280	16224	1038	16000	15132	1236	15040	14196	1363	14560	13728	1436	13600	12792	1537	13120	12324	1595
	64	77	14240	13884	890	18400	17628	1052	16960	16380	1250	16000	15444	1378	15360	14820	1436	14400	13884	1552	13760	13260	1610
	66	81	14720	14352	903	19040	18564	1065	17600	17160	1265	16640	16224	1392	16000	15600	1450	15040	14664	1552	14400	14040	1610
	72	86	16320	14196	903	21120	18408	1065	19520	17004	1265	18400	16068	1407	17760	15444	1465	16000	14976	1610	14880	14664	1697
	75	90	17440	14196	917	22560	18408	1079	20800	17004	1279	19680	16068	1407	18880	15444	1479	16640	15288	1653	15200	15132	1755
7K+12K	54	64	15770	14450	952	17860	19266	1131	16530	17784	1333	15580	16858	1472	15010	16117	1536	14060	15191	1648	13490	14450	1712
	57	68	15770	14450	952	19190	19266	1131	17860	17969	1348	16720	16858	1488	16150	16302	1552	15010	15191	1664	14440	14635	1744
	61	72	15770	15376	967																		



COOLING	INDOOR		OUTDOOR TEMPERATURE ("FDW)																							
	EWB	EDB	14			70			81			90			95			104			109					
	"F	"F	TC	SHC	PI	TC	SHC	PI	TC	SHC	PI	TC	SHC	PI	TC	SHC	PI	TC	SHC	PI	TC	SHC	PI			
9K+9K	54	64	14940	13689	952	16920	18252	1131	15660	16848	1333	14760	15971	1472	14220	15269	1536	13320	14391	1648	12780	13689	1712			
	57	68	14940	13689	952	18180	18252	1131	16920	17024	1348	15840	15971	1488	15300	15444	1552	14220	14391	1664	13680	13865	1744			
	61	72	14940	14567	967	19440	18252	1146	18000	17024	1364	16920	15971	1504	16380	15444	1584	15300	14391	1696	14760	13865	1760			
	64	77	16020	15620	982	20700	19832	1161	19080	18428	1380	18000	17375	1520	17280	16673	1584	16200	15620	1712	15480	14918	1776			
	66	81	16560	16146	997	21420	20885	1176	19800	19305	1396	18720	18252	1536	18000	17550	1600	16920	16497	1712	16200	15795	1776			
	72	86	18360	15971	997	23760	20709	1176	21960	19130	1396	20700	18077	1552	19980	17375	1616	18000	16848	1776	16740	16497	1872			
	75	90	19620	15971	1012	25380	20709	1190	23400	19130	1411	22140	18077	1552	21240	17375	1632	18720	17199	1824	17100	17024	1936			
9K+12K	54	64	17430	15971	1012	19740	21294	1202	18270	19656	1416	17220	18632	1564	16590	17813	1632	15540	16790	1751	14910	15971	1819			
	57	68	17430	15971	1012	21210	21294	1202	19740	19861	1433	18480	18632	1581	17850	18018	1649	16590	16790	1768	15960	16175	1853			
	61	72	17430	16994	1028	22680	21294	1217	21000	19861	1449	19740	18632	1598	19110	18018	1683	17850	16790	1802	17220	16175	1870			
	64	77	18690	18223	1043	24150	23137	1233	22260	21499	1466	21000	20270	1615	20160	19451	1683	18900	18223	1819	18060	17404	1887			
	66	81	19320	18837	1059	24990	24365	1249	23100	22523	1483	21840	21294	1632	21000	20475	1700	19740	19247	1819	18900	18428	1887			
	72	86	21420	18632	1059	27720	24161	1249	25620	22318	1483	24150	21089	1649	23310	20270	1717	21000	19656	1887	19530	19247	1989			
	75	90	22890	18632	1075	29610	24161	1265	27300	22318	1499	25830	21089	1649	24780	20270	1734	21840	20066	1938	19950	19861	2057			
9K+18K	54	64	19920	18252	1143	22560	24336	1357	20880	22464	1599	19680	21294	1766	18960	20358	1843	17760	19188	1978	17040	18252	2054			
	57	68	19920	18252	1143	24240	24336	1357	22560	22698	1618	21120	21294	1786	20400	20592	1862	18960	19188	1997	18240	18486	2093			
	61	72	19920	19422	1161	25920	24336	1375	24000	22698	1637	22560	21294	1805	21840	20592	1901	20400	19188	2035	19680	18486	2112			
	64	77	21360	20826	1178	27600	26442	1393	25440	24570	1656	24000	23166	1824	23040	22230	1901	21600	20826	2054	20640	19890	2131			
	66	81	22080	21528	1196	28560	27846	1411	26400	25740	1675	24960	24336	1843	24000	23400	1920	22560	21996	2054	21600	21060	2131			
	72	86	24480	21294	1196	31680	27612	1411	29280	25506	1675	27600	24102	1862	26640	23166	1939	24000	22464	2131	22320	21996	2246			
	75	90	26160	21294	1214	33840	27612	1428	31200	25506	1693	29520	24102	1862	28320	23166	1958	24960	22932	2189	22800	22698	2323			
12K+12K	54	64	19920	18252	1143	22560	24336	1357	20880	22464	1599	19680	21294	1766	18960	20358	1843	17760	19188	1978	17040	18252	2054			
	57	68	19920	18252	1143	24240	24336	1357	22560	22698	1618	21120	21294	1786	20400	20592	1862	18960	19188	1997	18240	18486	2093			
	61	72	19920	19422	1161	25920	24336	1375	24000	22698	1637	22560	21294	1805	21840	20592	1901	20400	19188	2035	19680	18486	2112			
	64	77	21360	20826	1178	27600	26442	1393	25440	24570	1656	24000	23166	1824	23040	22230	1901	21600	20826	2054	20640	19890	2131			
	66	81	22080	21528	1196	28560	27846	1411	26400	25740	1675	24960	24336	1843	24000	23400	1920	22560	21996	2054	21600	21060	2131			
	72	86	24480	21294	1196	31680	27612	1411	29280	25506	1675	27600	24102	1862	26640	23166	1939	24000	22464	2131	22320	21996	2246			
	75	90	26160	21294	1214	33840	27612	1428	31200	25506	1693	29520	24102	1862	28320	23166	1958	24960	22932	2189	22800	22698	2323			
12K+18K	54	64	19920	18252	1143	22560	24336	1357	20880	22464	1599	19680	21294	1766	18960	20358	1843	17760	19188	1978	17040	18252	2054			
	57	68	19920	18252	1143	24240	24336	1357	22560	22698	1618	21120	21294	1786	20400	20592	1862	18960	19188	1997	18240	18486	2093			
	61	72	19920	19422	1161	25920	24336	1375	24000	22698	1637	22560	21294	1805	21840	20592	1901	20400	19188	2035	19680	18486	2112			
	64	77	21360	20826	1178	27600	26442	1393	25440	24570	1656	24000	23166	1824	23040	22230	1901	21600	20826	2054	20640	19890	2131			
	66	81	22080	21528	1196	28560	27846	1411	26400	25740	1675	24960	24336	1843	24000	23400	1920	22560	21996	2054	21600	21060	2131			
	72	86	24480	21294	1196	31680	27612	1411	29280	25506	1675	27600	24102	1862	26640	23166	1939	24000	22464	2131	22320	21996	2246			
	75	90	26160	21294	1214	33840	27612	1428	31200	25506	1693	29520	24102	1862	28320	23166	1958	24960	22932	2189	22800	22698	2323			
18K+18K	54	64	19920	18252	1143	22560	24336	1357	20880	22464	1599	19680	21294	1766	18960	20358	1843	17760	19188	1978	17040	18252	2054			
	57	68	19920	18252	1143	24240	24336	1357	22560	22698	1618	21120	21294	1786	20400	20592	1862	18960	19188	1997	18240	18486	2093			
	61	72	19920	19422	1161	25920	24336	1375	24000	22698	1637	22560	21294	1805	21840	20592	1901	20400	19188	2035	19680	18486	2112			
	64	77	21360	20826	1178	27600	26442	1393	25440	24570	1656	24000	23166	1824	23040	22230	1901	21600	20826	2054	20640	19890	2131			
	66	81	22080	21528	1196	28560	27846	1411	26400	25740	1675	24960	24336	1843	24000	23400	1920	22560	21996	2054	21600	21060	2131			
	72	86	24480	21294	1196	31680	27612	1411	29280	25506	1675	27600	24102	1862	26640	23166	1939	24000	22464	2131	22320	21996	2246			
	75	90	26160	21294	1214	33840	27612	1428	31200	25506	1693	29520	24102	1862	28320	23166	1958	24960	22932	2189	22800	22698	2323			
7K+7K+7K	54	64	17430	15971	1012	19740	21294	1202	18270	19656	1416	17220	18632	1564	16590	17813	1632	15540	16790	1751	14910	15971	1819			
	57	68	17430	15971	1012	21210	21294	1202	19740	19861	1433	18480	18632	1581	17850	18018	1649	16590	16790	1768	15960	16175	1853			
	61	72	17430	16994	1028	22680	21294	1217	21000	19861	1449	19740	18632	1598	19110	18018	1683	17850	16790	1802	17220	16175	1870			
	64	77	18690	18223	1043	24150	23137	1233	22260	21499	1466	21000	20270	1615	20160	19451	1683	18900	18223	1819	18060	17404	1887			
	66	81	19320	18837	1059	24990	24365	1249	23100	22523	1483	21840	21294	1632	21000	20475	1700	19740	19247	1819	18900	18428	1887			
	72	86	21420	18632	1059	27720	24161	1249	25620	22318	1483	24150	21089	1649	23310	20270	1717	21000	19656	1887	19530	19247	1989			
	75	90	22890	18632	1075	29610	24161	1265	27300	22318	1499	25830	21089	1649	24780	20270	1734	21840	20066	1938	19950	19861	2057			
7K+7K+9K	54	64	19090	17492	1071	21620	23322	1272	20010	21528	1499	18860	20407	1656	18170	19510	1728	17020	18389	1854	16330	17492	1926			
	57	68	19090	17492	1071	23230	23322	1272	21620	21752	1517	20240	20407	1674	19550	19734	1746	18170	18389	1872	17480	17716	1962			
	61	72	19090	17493	1088	24840	23322	1289	23000	21752	1535	21620	20													



COOLING	INDOOR		OUTDOOR TEMPERATURE (*°FDW)																				
	EWB	EDB	14			70			81			90			95			104			109		
	*F	*F	TC	SHC	PI	TC	SHC	PI	TC	SHC	PI	TC	SHC	PI	TC	SHC	PI	TC	SHC	PI	TC	SHC	PI
7K+9K+9K	54	64	19920	18252	1143	22560	24336	1357	20880	22464	1599	19680	21294	1766	18960	20358	1843	17760	19188	1978	17040	18252	2054
	57	68	19920	18252	1143	24240	24336	1357	22560	22698	1618	21120	21294	1786	20400	20592	1862	18960	19188	1997	18240	18486	2093
	61	72	19920	19422	1161	25920	24336	1375	24000	22698	1637	22560	21294	1805	21840	20592	1901	20400	19188	2035	19680	18486	2112
	64	77	21360	20826	1178	27600	26442	1393	25440	24570	1656	24000	23166	1824	23040	22230	1901	21600	20826	2054	20640	19890	2131
	66	81	22080	21528	1196	28560	27846	1411	26400	25740	1675	24960	24336	1843	24000	23400	1920	22560	21996	2054	21600	21060	2131
	72	86	24480	21294	1196	31680	27612	1411	29280	25506	1675	27600	24102	1862	26640	23166	1939	24000	22464	2131	22320	21996	2246
	75	90	26160	21294	1214	33840	27612	1428	31200	25506	1693	29520	24102	1862	28320	23166	1958	24960	22932	2189	22800	22698	2323
7K+9K+12K	54	64	19920	18252	1143	22560	24336	1357	20880	22464	1599	19680	21294	1766	18960	20358	1843	17760	19188	1978	17040	18252	2054
	57	68	19920	18252	1143	24240	24336	1357	22560	22698	1618	21120	21294	1786	20400	20592	1862	18960	19188	1997	18240	18486	2093
	61	72	19920	19422	1161	25920	24336	1375	24000	22698	1637	22560	21294	1805	21840	20592	1901	20400	19188	2035	19680	18486	2112
	64	77	21360	20826	1178	27600	26442	1393	25440	24570	1656	24000	23166	1824	23040	22230	1901	21600	20826	2054	20640	19890	2131
	66	81	22080	21528	1196	28560	27846	1411	26400	25740	1675	24960	24336	1843	24000	23400	1920	22560	21996	2054	21600	21060	2131
	72	86	24480	21294	1196	31680	27612	1411	29280	25506	1675	27600	24102	1862	26640	23166	1939	24000	22464	2131	22320	21996	2246
	75	90	26160	21294	1214	33840	27612	1428	31200	25506	1693	29520	24102	1862	28320	23166	1958	24960	22932	2189	22800	22698	2323
7K+9K+18K	54	64	19920	18252	1143	22560	24336	1357	20880	22464	1599	19680	21294	1766	18960	20358	1843	17760	19188	1978	17040	18252	2054
	57	68	19920	18252	1143	24240	24336	1357	22560	22698	1618	21120	21294	1786	20400	20592	1862	18960	19188	1997	18240	18486	2093
	61	72	19920	19422	1161	25920	24336	1375	24000	22698	1637	22560	21294	1805	21840	20592	1901	20400	19188	2035	19680	18486	2112
	64	77	21360	20826	1178	27600	26442	1393	25440	24570	1656	24000	23166	1824	23040	22230	1901	21600	20826	2054	20640	19890	2131
	66	81	22080	21528	1196	28560	27846	1411	26400	25740	1675	24960	24336	1843	24000	23400	1920	22560	21996	2054	21600	21060	2131
	72	86	24480	21294	1196	31680	27612	1411	29280	25506	1675	27600	24102	1862	26640	23166	1939	24000	22464	2131	22320	21996	2246
	75	90	26160	21294	1214	33840	27612	1428	31200	25506	1693	29520	24102	1862	28320	23166	1958	24960	22932	2189	22800	22698	2323
7K+12K+12K	54	64	19920	18252	1143	22560	24336	1357	20880	22464	1599	19680	21294	1766	18960	20358	1843	17760	19188	1978	17040	18252	2054
	57	68	19920	18252	1143	24240	24336	1357	22560	22698	1618	21120	21294	1786	20400	20592	1862	18960	19188	1997	18240	18486	2093
	61	72	19920	19422	1161	25920	24336	1375	24000	22698	1637	22560	21294	1805	21840	20592	1901	20400	19188	2035	19680	18486	2112
	64	77	21360	20826	1178	27600	26442	1393	25440	24570	1656	24000	23166	1824	23040	22230	1901	21600	20826	2054	20640	19890	2131
	66	81	22080	21528	1196	28560	27846	1411	26400	25740	1675	24960	24336	1843	24000	23400	1920	22560	21996	2054	21600	21060	2131
	72	86	24480	21294	1196	31680	27612	1411	29280	25506	1675	27600	24102	1862	26640	23166	1939	24000	22464	2131	22320	21996	2246
	75	90	26160	21294	1214	33840	27612	1428	31200	25506	1693	29520	24102	1862	28320	23166	1958	24960	22932	2189	22800	22698	2323
9K+9K+9K	54	64	19920	18252	1143	22560	24336	1357	20880	22464	1599	19680	21294	1766	18960	20358	1843	17760	19188	1978	17040	18252	2054
	57	68	19920	18252	1143	24240	24336	1357	22560	22698	1618	21120	21294	1786	20400	20592	1862	18960	19188	1997	18240	18486	2093
	61	72	19920	19422	1161	25920	24336	1375	24000	22698	1637	22560	21294	1805	21840	20592	1901	20400	19188	2035	19680	18486	2112
	64	77	21360	20826	1178	27600	26442	1393	25440	24570	1656	24000	23166	1824	23040	22230	1901	21600	20826	2054	20640	19890	2131
	66	81	22080	21528	1196	28560	27846	1411	26400	25740	1675	24960	24336	1843	24000	23400	1920	22560	21996	2054	21600	21060	2131
	72	86	24480	21294	1196	31680	27612	1411	29280	25506	1675	27600	24102	1862	26640	23166	1939	24000	22464	2131	22320	21996	2246
	75	90	26160	21294	1214	33840	27612	1428	31200	25506	1693	29520	24102	1862	28320	23166	1958	24960	22932	2189	22800	22698	2323
9K+9K+12K	54	64	19920	18252	1143	22560	24336	1357	20880	22464	1599	19680	21294	1766	18960	20358	1843	17760	19188	1978	17040	18252	2054
	57	68	19920	18252	1143	24240	24336	1357	22560	22698	1618	21120	21294	1786	20400	20592	1862	18960	19188	1997	18240	18486	2093
	61	72	19920	19422	1161	25920	24336	1375	24000	22698	1637	22560	21294	1805	21840	20592	1901	20400	19188	2035	19680	18486	2112
	64	77	21360	20826	1178	27600	26442	1393	25440	24570	1656	24000	23166	1824	23040	22230	1901	21600	20826	2054	20640	19890	2131
	66	81	22080	21528	1196	28560	27846	1411	26400	25740	1675	24960	24336	1843	24000	23400	1920	22560	21996	2054	21600	21060	2131
	72	86	24480	21294	1196	31680	27612	1411	29280	25506	1675	27600	24102	1862	26640	23166	1939	24000	22464	2131	22320	21996	2246
	75	90	26160	21294	1214	33840	27612	1428	31200	25506	1693	29520	24102	1862	28320	23166	1958	24960	22932	2189	22800	22698	2323
9K+9K+18K	54	64	19920	18252	1143	22560	24336	1357	20880	22464	1599	19680	21294	1766	18960	20358	1843	17760	19188	1978	17040	18252	2054
	57	68	19920	18252	1143	24240	24336	1357	22560	22698	1618	21120	21294	1786	20400	20592	1862	18960	19188	1997	18240	18486	2093
	61	72	19920	19422	1161	25920	24336	1375	24000	22698	1637	22560	21294	1805	21840	20592	1901	20400	19188	2035	19680	18486	2112
	64	77	21360	20826	1178	27600	26442	1393	25440	24570	1656	24000	23166	1824	23040	22230	1901	21600	20826	2054	20640	19890	2131
	66	81	22080	21528	1196	28560	27846	1411	26400	25740	1675	24960	24336	1843	24000	23400	1920	22560	21996	2054	21600	21060	2131
	72	86	24480	21294	1196	31680	27612	1411	29280	25506	1675	27600	24102	1862	26640	23166	1939	24000	22464	2131	22320	21996	2246
	75	90	26160	21294	1214	33840	27612	1428	31200	25506	1693	29520	24102	1862	28320	23166	1958	24960	22932	2189	22800	22698	2323
9K+12K+12K	54	64	19920	18252	1143	22560	24336	1357	20880	22464	1599	19680	21294	1766	18960	20358	1843	17760	19188	1978	17040	18252	2054
	57	68	19920	18252	1143	24240	24336	1357	22560	22698	1618	21120	21294	1786	20400	20592	1862	18960	19188	1997	18240	18486	2093
	61	72	19920	19422	1161	25920	24336	1375	24000	22698	1637	22560	21294	1805	21840	20592	1901	20400	19188	2035	19680	18486	2112
	64	77	21360	20826	1178	27600	26442	1393	25440	24570	1656	24000	23166	1824	23040	22230	1901	21600	20826	2054	20640	19890	2131
	66	81	22080	21528	1196	28560	27846	1411	26400	25740	1675	24960	24336	1843	24000	23400	1920	22560	21996	2054	21600	21060	2131
	72	86	24480	2																			

EWB : Evaporator Wet Bulb temperature (°F)

EDB : Evaporator Dry Bulb temperature (°F)

(°FDB) : Outdoor Unit Inlet Air Dry Temperature (°F)

TC : Total Capacity (Btu)

SHC : Sensible Heating Capacity (Btu)

PI : Power Input (W)



## HEATING [60Hz, 230V]

		INDOOR		OUTDOOR TEMPERATURE ("FDW)																							
		EDB		5		14		17		23		32		47		50		59									
		"F		TC	SHC	PI	TC	SHC	PI	TC	SHC	PI	TC	SHC	PI	TC	SHC	PI	TC	SHC	PI						
RAM-S24U3YHAB	61	18780		2420	19342		2462	19754		2457	21035		2430	24148		2402	28322		2283	28646		2297	29418		2314		
	64	18640		2445	19202		2486	19577		2497	20832		2479	23924		2454	28161		2381	28492		2400	29159		2429		
	68	18500		2470	19062		2511	19400		2536	20629		2528	23700		2507	28000		2478	28338		2503	28900		2544		
	72	18360		2495	18922		2536	19223		2575	20426		2577	23476		2560	27839		2575	28184		2606	28641		2659		
	75	18220		2520	18782		2561	19047		2615	20223		2626	23252		2612	27678		2673	28030		2708	28382		2774		
7K	61	6036		610	6217		632	6349		637	6761		640	7762		659	9104		663	9207		673	9456		688		
	64	5991		617	6172		639	6293		648	6696		654	7690		674	9052		692	9158		703	9373		721		
	68	5946		625	6127		646	6236		660	6631		668	7618		690	9000		720	9108		733	9289		755		
	72	5901		632	6082		654	6179		671	6565		682	7546		705	8948		748	9059		763	9206		788		
9K	75	5856		639	6037		661	6122		682	6500		697	7474		720	8897		777	9009		793	9123		822		
	61	7780		831	8013		860	8184		867	8714		871	10004		897	11733		903	11867		916	12187		936		
	64	7722		840	7955		870	8110		882	8630		890	9911		918	11667		942	11804		957	12080		982		
	68	7664		850	7897		880	8037		898	8546		909	9819		939	11600		980	11740		998	11973		1027		
	72	7606		860	7839		890	7964		913	8462		929	9726		960	11533		1018	11676		1038	11866		1073		
12K	75	7548		870	7781		900	7891		929	8378		948	9633		981	11467		1057	11612		1079	11758		1119		
	61	10295		975	10604		1010	10829		1017	11531		1022	13238		1053	15527		1060	15704		1075	16127		1099		
	64	10219		986	10527		1021	10732		1035	11420		1045	13115		1077	15438		1105	15619		1123	15985		1152		
	68	10142		998	10450		1033	10635		1053	11309		1067	12993		1102	15350		1150	15535		1171	15843		1206		
	72	10065		1009	10374		1044	10538		1072	11198		1090	12870		1126	15262		1195	15451		1219	15701		1259		
18K	75	9988		1021	10297		1056	10442		1090	11086		1113	12747		1151	15173		1240	15366		1266	15559		1313		
	61	13750		1653	14161		1712	14462		1725	15400		1733	17680		1785	20736		1797	20973		1824	21538		1863		
	64	13647		1672	14059		1731	14333		1755	15252		1771	17516		1827	20618		1873	20860		1904	21349		1954		
	68	13545		1692	13956		1751	14204		1786	15103		1810	17352		1868	20500		1950	20747		1985	21159		2044		
	72	13442		1711	13854		1770	14074		1817	14954		1848	17188		1910	20382		2027	20634		2066	20969		2135		
7K+7K	75	13340		1731	13751		1790	13945		1848	14806		1887	17024		1951	20264		2103	20522		2147	20780		2226		
	61	12073		1271	12434		1317	12699		1327	13522		1333	15524		1373	18207		1382	18415		1403	18912		1433		
	64	11983		1286	12344		1332	12585		1350	13392		1362	15380		1405	18104		1441	18316		1465	18745		1503		
	68	11893		1301	12254		1347	12471		1374	13261		1392	15236		1437	18000		1500	18217		1527	18579		1573		
	72	11803		1316	12164		1362	12358		1398	13131		1422	15092		1469	17897		1559	18118		1589	18412		1642		
7K+9K	75	11713		1331	12074		1377	12244		1422	13000		1451	14948		1501	17793		1618	18019		1652	18246		1712		
	61	13817		1483	14231		1536	14533		1548	15475		1555	17766		1602	20837		1613	21075		1637	21643		1672		
	64	13714		1501	14128		1554	14403		1575	15326		1590	17601		1639	20718		1681	20962		1709	21453		1753		
	68	13611		1518	14025		1571	14273		1603	15177		1624	17436		1677	20600		1750	20848		1782	21262		1835		
	72	13508		1536	13922		1589	14143		1631	15027		1659	17272		1714	20482		1819	20735		1854	21072		1916		
7K+12K	75	13405		1553	13819		1606	14013		1659	14878		1693	17107		1751	20363		1887	20622		1927	20881		1998		
	61	16332		1653	16821		1712	17178		1725	18293		1733	21000		1785	24630		1797	24911		1824	25583		1863		
	64	16210		1672	16699		1731	17025		1755	18116		1771	20805		1827	24490		1873	24777		1904	25358		1954		
	68	16088		1692	16578		1751	16871		1786	17939		1810	20611		1868	24350		1950	24644		1985	25133		2044		
	72	15967		1711	16456		1770	16717		1817	17763		1848	20416		1910	24210		2027	24510		2066	24907		2135		
7K+18K	75	15845		1731	16334		1790	16564		1848	17586		1887	20221		1951	24070		2103	24376		2147	24682		2226		
	61	18780		2420	19342		2462	19754		2457	21035		2430	24148		2402	28322		2283	28646		2297	29418		2314		
	64	18640		2445	19202		2486	19577		2497	20832		2479	23924		2454	28161		2381	28492		2400	29159		2429		
	68	18500		2470	19062		2511	19400		2536	20629		2528	23700		2507	28000		2478	28338		2503	28900		2544		
	72	18360		2495	18922		2536	19223		2575	20426		2577	23476		2560	27839		2575	28184		2606	28641		2659		
9K+9K	75	18220		2520	18782		2561	19047		2615	20223		2626	23252		2612	27678		2673	28030		2708	28382		2774		
	61	15561		1653	16027		1712	16367		1725	17429		1733	20008		1785	23467		1797	23735		1824	24375		1863		
	64	15445		1672	15911		1731	16221		1755	17260		1771	19823		1827	23333		1873	23607		1904	24160		1954		
	68	15329		1692	15795		1751	16074		1786	17092		1810	19637		1868	23200		1950	23480		1985	23946		2044		
	72	15213		1711	15679		1770	15928		1817	16924		1848	19452		1910	23067		2027	23352		2066	23731		2135		
9K+12K	75	15097		1731	15563		1790	15781		1848	16756		1887	19266		1951	22933		2103	23224		2147	23517		2226		
	61	18076		1738	18617		1800	19013		1813	20246		1822	23242		1877	27260		1889	27571		1917	28315		1959		
	64	17941		1758	18482		1820	18843		1845	20050		1862	23027		1920	27105		1970	27423		2002	28066		2054		
	68	17806		1779	18348		1841	18672		1878	19855		1903	22811		1964	26950		2050	27275		2087	27816		2149		
	72	17671		1799	18213		1861	18502		1910	19660		1943	22596		2008	26795		2130	27127		2172	27567		2245		
9K+18K	75	17537		1820	18078		181																				



	INDOOR	OUTDOOR TEMPERATURE (°FDW)																							
	EDB	5			14			17			23			32			47			50			59		
	°F	TC	SHC	PI	TC	SHC	PI	TC	SHC	PI	TC	SHC	PI	TC	SHC	PI	TC	SHC	PI	TC	SHC	PI	TC	SHC	PI
18K+18K	61	18780		2420	19342		2462	19754		2457	21035		2430	24148		2402	28322		2283	28646		2297	29418		2314
	64	18640		2445	19202		2486	19577		2497	20832		2479	23924		2454	28161		2381	28492		2400	29159		2429
	68	18500		2470	19062		2511	19400		2536	20629		2528	23700		2507	28000		2478	28338		2503	28900		2544
	72	18360		2495	18922		2536	19223		2575	20426		2577	23476		2560	27839		2575	28184		2606	28641		2659
	75	18220		2520	18782		2561	19047		2615	20223		2626	23252		2612	27678		2673	28030		2708	28382		2774
7K+7K+7K	61	18109		1738	18652		1800	19048		1813	20283		1822	23286		1877	27311		1889	27622		1917	28367		1959
	64	17974		1758	18517		1820	18878		1845	20088		1862	23070		1920	27155		1970	27474		2002	28118		2054
	68	17839		1779	18382		1841	18707		1878	19892		1903	22854		1964	27000		2050	27325		2087	27868		2149
	72	17704		1799	18247		1861	18537		1910	19696		1943	22638		2008	26845		2130	27177		2172	27618		2245
	75	17569		1820	18112		1882	18366		1943	19500		1983	22422		2051	26690		2211	27028		2257	27368		2340
7K+7K+9K	61	18780		1941	19342		2010	19753		2025	21035		2035	24148		2097	28322		2110	28646		2142	29418		2188
	64	18640		1964	19202		2033	19577		2061	20832		2080	23924		2145	28161		2200	28492		2237	29159		2294
	68	18500		1987	19062		2056	19400		2098	20629		2125	23700		2194	28000		2290	28338		2332	28900		2401
	72	18360		2010	18922		2079	19223		2134	20426		2170	23476		2243	27839		2380	28184		2427	28641		2507
	75	18220		2033	18782		2102	19046		2170	20223		2216	23252		2291	27678		2470	28030		2522	28382		2614
7K+7K+12K	61	18780		2420	19342		2462	19754		2457	21035		2430	24148		2402	28322		2283	28646		2297	29418		2314
	64	18640		2445	19202		2486	19577		2497	20832		2479	23924		2454	28161		2381	28492		2400	29159		2429
	68	18500		2470	19062		2511	19400		2536	20629		2528	23700		2507	28000		2478	28338		2503	28900		2544
	72	18360		2495	18922		2536	19223		2575	20426		2577	23476		2560	27839		2575	28184		2606	28641		2659
	75	18220		2520	18782		2561	19047		2615	20223		2626	23252		2612	27678		2673	28030		2708	28382		2774
7K+7K+18K	61	18780		2420	19342		2462	19754		2457	21035		2430	24148		2402	28322		2283	28646		2297	29418		2314
	64	18640		2445	19202		2486	19577		2497	20832		2479	23924		2454	28161		2381	28492		2400	29159		2429
	68	18500		2470	19062		2511	19400		2536	20629		2528	23700		2507	28000		2478	28338		2503	28900		2544
	72	18360		2495	18922		2536	19223		2575	20426		2577	23476		2560	27839		2575	28184		2606	28641		2659
	75	18220		2520	18782		2561	19047		2615	20223		2626	23252		2612	27678		2673	28030		2708	28382		2774
7K+9K+9K	61	18780		2420	19342		2462	19754		2457	21035		2430	24148		2402	28322		2283	28646		2297	29418		2314
	64	18640		2445	19202		2486	19577		2497	20832		2479	23924		2454	28161		2381	28492		2400	29159		2429
	68	18500		2470	19062		2511	19400		2536	20629		2528	23700		2507	28000		2478	28338		2503	28900		2544
	72	18360		2495	18922		2536	19223		2575	20426		2577	23476		2560	27839		2575	28184		2606	28641		2659
	75	18220		2520	18782		2561	19047		2615	20223		2626	23252		2612	27678		2673	28030		2708	28382		2774
7K+9K+12K	61	18780		2420	19342		2462	19754		2457	21035		2430	24148		2402	28322		2283	28646		2297	29418		2314
	64	18640		2445	19202		2486	19577		2497	20832		2479	23924		2454	28161		2381	28492		2400	29159		2429
	68	18500		2470	19062		2511	19400		2536	20629		2528	23700		2507	28000		2478	28338		2503	28900		2544
	72	18360		2495	18922		2536	19223		2575	20426		2577	23476		2560	27839		2575	28184		2606	28641		2659
	75	18220		2520	18782		2561	19047		2615	20223		2626	23252		2612	27678		2673	28030		2708	28382		2774
7K+9K+18K	61	18780		2420	19342		2462	19754		2457	21035		2430	24148		2402	28322		2283	28646		2297	29418		2314
	64	18640		2445	19202		2486	19577		2497	20832		2479	23924		2454	28161		2381	28492		2400	29159		2429
	68	18500		2470	19062		2511	19400		2536	20629		2528	23700		2507	28000		2478	28338		2503	28900		2544
	72	18360		2495	18922		2536	19223		2575	20426		2577	23476		2560	27839		2575	28184		2606	28641		2659
	75	18220		2520	18782		2561	19047		2615	20223		2626	23252		2612	27678		2673	28030		2708	28382		2774
7K+12K+12K	61	18780		2420	19342		2462	19754		2457	21035		2430	24148		2402	28322		2283	28646		2297	29418		2314
	64	18640		2445	19202		2486	19577		2497	20832		2479	23924		2454	28161		2381	28492		2400	29159		2429
	68	18500		2470	19062		2511	19400		2536	20629		2528	23700		2507	28000		2478	28338		2503	28900		2544
	72	18360		2495	18922		2536	19223		2575	20426		2577	23476		2560	27839		2575	28184		2606	28641		2659
	75	18220		2520	18782		2561	19047		2615	20223		2626	23252		2612	27678		2673	28030		2708	28382		2774
9K+9K+9K	61	18780		2420	19342		2462	19754		2457	21035		2430	24148		2402	28322		2283	28646		2297	29418		2314
	64	18640		2445	19202		2486	19577		2497	20832		2479	23924		2454	28161		2381	28492		2400	29159		2429
	68	18500		2470	19062		2511	19400		2536	20629		2528	23700		2507	28000		2478	28338		2503	28900		2544
	72	18360		2495	18922		2536	19223		2575	20426		2577	23476		2560	27839		2575	28184		2606	28641		2659
	75	18220		2520	18782		2561	19047		2615	20223		2626	23252		2612	27678		2673	28030		2708	28382		2774
9K+9K+12K	61	18780		2420	19342		2462	19754		2457	21035		2430	24148		2402	28322		2283	28646		2297	29418		2314
	64	18640		2445	19202		2486	19577		2497	20832		2479	23924		2454	28161		2381	28492		2400	29159		2429
	68	18500		2470	19062		2511	19400		2536	20629		2528	23700		2507	28000		2478	28338		2503	28900		2544
	72	18360		2495	18922		2536	19223		2575	20426														



### 3.3. CORRECTION FACTORS ACCORDING TO PIPING LENGTH

Correction Factor for **Cooling Capacity** according to Piping Length

The cooling capacity should be corrected according to the following formula:

$$CCA = CC \times F$$

CCA: Actual Corrected Cooling Capacity  
(kcal/h)

CC: Cooling Capacity in the Performance  
Table (kcal/h)

F: Correction Factor Based on the  
Equivalent Piping Length

Correction Factor for **Heating Capacity** according to Piping Length

The heating capacity should be corrected according to the following formula:

$$HCA = HC \times F$$

HCA: Actual Corrected Heating Capacity  
(kcal/h)

HC: Heating Capacity in the Performance  
Table (kcal/h)

F: Correction Factor Based on the  
Equivalent Piping Length

The correction factors are shown in the following figure.

Equivalent Piping Length for:

- One 90° Elbow is 0.5m.
- One 180° Curve is 1.5m.

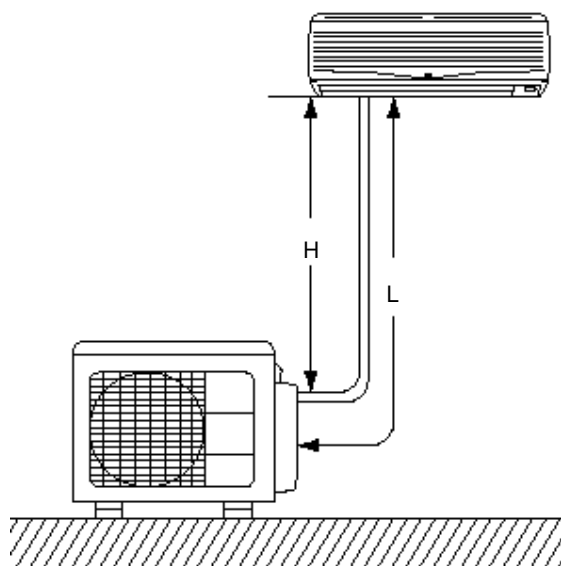

H: Vertical Distance Between Indoor Unit and Outdoor Units in Meters

L: Actual One-Way Piping Length Between Indoor Unit and Outdoor Unit in Meters

EL: Equivalent Total Distance Between Indoor Unit and Outdoor Unit in Meters  
(Equivalent One-Way Piping Length)



Model Multi Outdoor 24000 BTU/h

RAM-S24U3HLAE

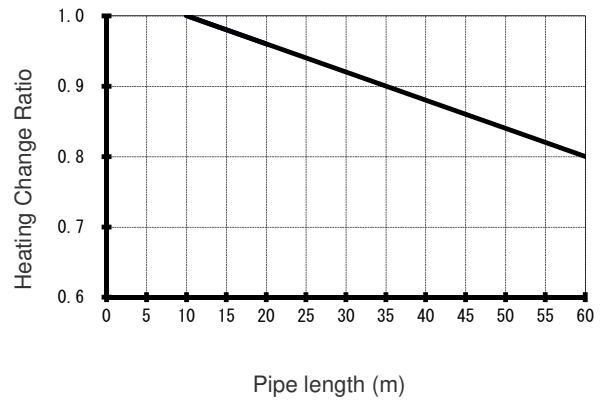
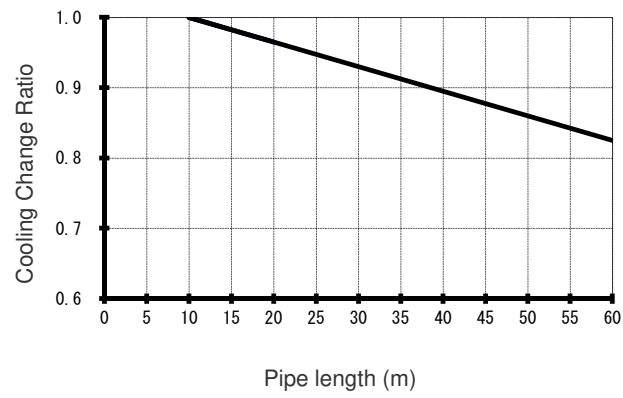



3.4. CORRECTION FACTORS ACCORDING TO DEFROSTING OPERATION

The heating capacity in the preceding paragraph, excludes the condition of the frost or the defrosting operation period. In consideration of the frost or the defrosting operation, the heating capacity is corrected by the equation below.

Corrected heating capacity = Defrost Correction factor    x    unit capacity

OUTDOOR TEMPERATURE (°CDB)	-15	-10	-7	-5	0	7	10	15
Correction factor (humidity rate85% RH)	0.95	0.95	0.89	0.85	0.81	1.0	1.0	1.0

Correction Factor

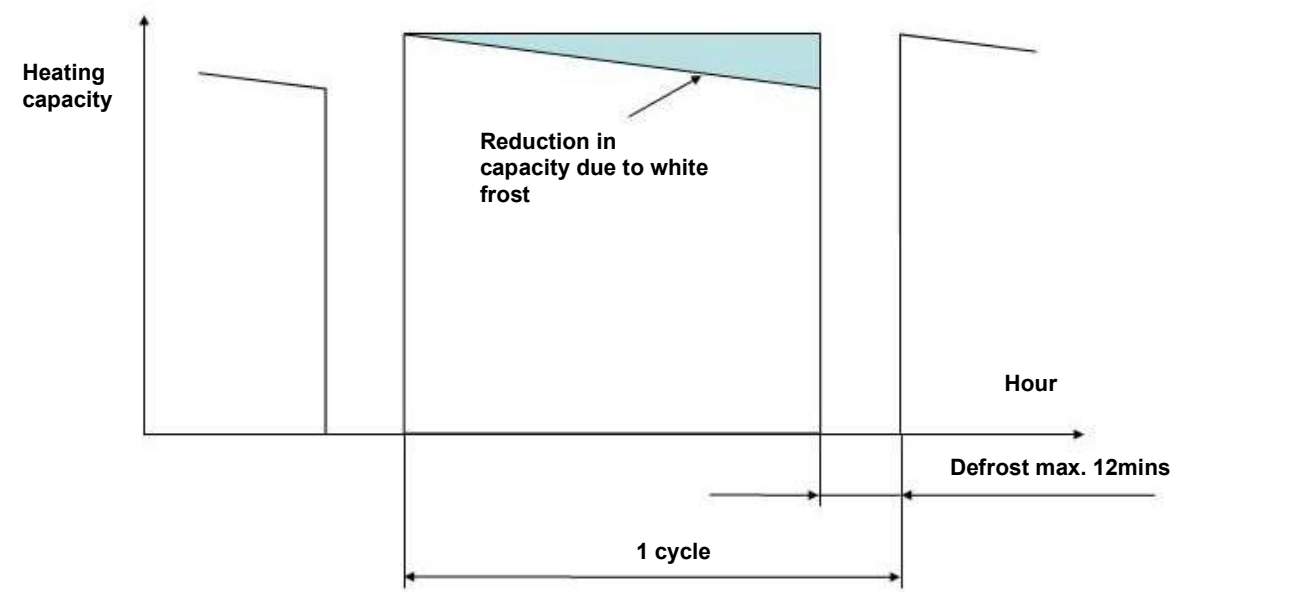

**NOTE:**  
The correction factor is not valid for special conditions such as snowfall or operation in a transitional period.



### 3.5. COMBINATION TABLE FOR MULTIZONE OUTDOOR

Whichever indoor units are installed, cooling and heating capacity depends on how many and which indoor units are operating at that time.

#### 3 ROOM MULTI-SPLIT INVERTER TYPE RAC: RAM-S24U3HLAE POSSIBLE COMBINATION TO OPERATE (SAME TIME OPERATION)

POSSIBLE COMBINATIONS TO OPERATE			COOLING					HEATING				
			CAPACITY RATING(BTU) (RANGE)	TOTAL	OUTDOOR UNIT		EER	CAPACITY RATING(BTU) (RANGE)	TOTAL	OUTDOOR UNIT		COP
					CONSUMPTION (W)	AMPERE(A)at 208 - 230				CONSUMPTION (W)	AMPERE(A)at 208 - 230	
ONE UNIT	7K	7K	7000 (3050-8500)	7000	450 (280-500)	2.16 - 1.96	15.6	9000 (3050-10900)	9000	720 (320-1130)	3.46 - 3.13	12.5
	9K	9K	9000 (3050-10200)	9000	650 (280-720)	3.13 - 2.83	13.8	11600 (3050-15000)	11600	980 (320-1480)	4.71 - 4.26	11.8
	12K	12K	12000 (3050-13650)	12000	1030 (280-1130)	4.95 - 4.48	11.7	15350 (3050-18000)	15350	1150 (320-1950)	5.53 - 5.00	13.3
	18K	18K	18000 (3050-17750)	18000	1600 (280-2200)	7.69 - 6.96	11.9	20500 (3050-23200)	20500	1950 (460-2100)	9.38 - 8.48	11.3
TWO UNIT	14K	7K+7K	7000+7000 (7000-17000)	14000	1250 (460-1800)	6.01 - 5.43	11.2	9000+9000 (9000-21000)	18000	1500 (390-1800)	7.20 - 6.52	12.0
	16K	7K+9K	7000+9000 (7000-19000)	16000	1450 (460-2000)	6.97 - 6.30	11.0	9000+11600 (9000-23000)	20600	1750 (390-2000)	8.41 - 7.61	11.8
	19K	7K+12K	7000+12000 (7000-21500)	19000	1600 (460-2200)	7.69 - 6.96	11.9	9000+15350 (9000-29000)	24350	1950 (460-2100)	9.38 - 8.48	11.3
	25K	7K+18K	6720+17280 (7000-28800)	24000	1920 (460-3700)	9.23 - 8.35	12.5	7840+20160 (9000-32000)	28000	2478 (460-2900)	11.91 - 10.77	11.3
	18K	9K+9K	9000+9000 (7000-21000)	18000	1600 (460-2200)	7.69 - 6.96	11.9	11600+11600 (9000-28500)	23200	1950 (460-2100)	9.38 - 8.48	11.3
	21K	9K+12K	9000+12000 (7000-25000)	21000	1700 (460-2400)	8.17 - 7.39	12.4	11600+15350 (9000-30000)	26950	2050 (460-2500)	9.86 - 8.91	13.2
	27K	9K+18K	8000+16000 (7000-28800)	24000	1920 (460-3700)	9.23 - 8.35	12.5	9333+18666 (9000-32000)	28000	2478 (460-2900)	11.91 - 10.77	11.3
	24K	12K+12K	12000+12000 (7000-28800)	24000	1920 (460-3700)	9.23 - 8.35	12.5	14000+14000 (9000-32000)	28000	2478 (460-2900)	11.91 - 10.77	11.3
	30K	12K+18K	9600+14400 (7000-28800)	24000	1920 (460-3700)	9.23 - 8.35	12.5	11200+16800 (9000-32000)	28000	2478 (460-2900)	11.91 - 10.77	11.3
	36K	18K+18K	12000+12000 (7000-28800)	24000	1920 (460-3700)	9.23 - 8.35	12.5	14000+14000 (9000-32000)	28000	2478 (460-2900)	11.91 - 10.77	11.3
THREE UNIT	21K	7K+7K+7K	7000+7000+7000 (7000-25000)	21000	1700 (460-2400)	8.17 - 7.39	12.4	9000+9000+9000 (9000-30000)	27000	2050 (460-2500)	9.86 - 8.91	13.2
	23K	7K+7K+9K	7000+7000+9000 (7000-27000)	23000	1800 (460-2600)	8.65 - 7.83	12.7	8500+8500+11000 (9000-32000)	28000	2290 (460-2600)	11.01 - 9.96	12.9
	26K	7K+7K+12K	6500+6500+11000 (7000-28800)	24000	1920 (460-3700)	9.23 - 8.35	12.5	7600+7600+12800 (9000-32000)	28000	2478 (460-2900)	11.91 - 10.77	11.3
	32K	7K+7K+18K	5250+5250+13500 (7000-28800)	24000	1920 (460-3700)	9.23 - 8.35	12.5	6125+6125+15750 (9000-32000)	28000	2478 (460-2900)	11.91 - 10.77	11.3
	25K	7K+9K+9K	6720+8640+8640 (7000-28800)	24000	1920 (460-3700)	9.23 - 8.35	12.5	7840+10080+10080 (9000-32000)	28000	2478 (460-2900)	11.91 - 10.77	11.3
	28K	7K+9K+12K	6000+7700+10300 (7000-28800)	24000	1920 (460-3700)	9.23 - 8.35	12.5	7000+9000+12000 (9000-32000)	28000	2478 (460-2900)	11.91 - 10.77	11.3
	34K	7K+9K+18K	5000+6300+12700 (7000-28800)	24000	1920 (460-3700)	9.23 - 8.35	12.5	5800+7400+14800 (9000-32000)	28000	2478 (460-2900)	11.91 - 10.77	11.3
	31K	7K+12K+12K	5400+9300+9300 (7000-28800)	24000	1920 (460-3700)	9.23 - 8.35	12.5	6350+10825+10825 (9000-32000)	28000	2478 (460-2900)	11.91 - 10.77	11.3
	27K	9K+9K+9K	8000+8000+8000 (7000-28800)	24000	1920 (460-3700)	9.23 - 8.35	12.5	9333+9333+9333 (9000-32000)	28000	2478 (460-2900)	11.91 - 10.77	11.3
	30K	9K+9K+12K	7200+7200+9600 (7000-28800)	24000	1920 (460-3700)	9.23 - 8.35	12.5	8400+8400+11200 (9000-32000)	28000	2478 (460-2900)	11.91 - 10.77	11.3
	36K	9K+9K+18K	6000+6000+12000 (7000-28800)	24000	1920 (460-3700)	9.23 - 8.35	12.5	7000+7000+14000 (9000-32000)	28000	2478 (460-2900)	11.91 - 10.77	11.3
	33K	9K+12K+12K	6500+8750+8750 (7000-28800)	24000	1920 (460-3700)	9.23 - 8.35	12.5	7650+10175+10175 (9000-32000)	28000	2478 (460-2900)	11.91 - 10.77	11.3
	36K	12K+12K+12K	8000+8000+8000 (7000-28800)	24000	1920 (460-3700)	9.23 - 8.35	12.5	9333+9333+9333 (9000-32000)	28000	2478 (460-2900)	11.91 - 10.77	11.3

\* TWO INDOOR UNITS SHOULD BE CONNECTED AT LEAST.

\* TOTAL NOMINAL COOLING CAPACITY SHOULD NOT BE MORE THAN 36K Btu.

<REMARKS>

\* ONE UNIT INDICATED ARE ONLY FOR ONE UNIT OPERATION WHEN TWO OR THREE OR FOUR INDOOR UNITS ARE CONNECTED.

\* TWO UNITS INDICATED ARE ONLY FOR TWO UNITS OPERATION WHEN TWO OR THREE OR FOUR INDOOR UNITS ARE CONNECTED.

\* THREE UNITS INDICATED ARE ONLY FOR THREE UNITS OPERATION WHEN THREE OR FOUR INDOOR UNITS ARE CONNECTED.

RATING CONDITON (DRY BLUB / WET BULB)

	INDOOR °F ( °C)	OUTDOOR °F ( °C)
COOLING	80/67 (26.67/19.44)	95/75 (35/23.89)
HEATING	70/60 (21.11/15.56)	47/43 (8.33/6.11)



NOMINAL COOLING CAPACITY(Btu)	indoor unit model	CAPACITY(Btu) at one unit operation		SUITABLE ROOM SIZE(m <sup>2</sup> ) at one unit operation	
		cooling	heating	cooling	heating
7K Btu	RAF-SH07QHAE	3050-9000	3050-10900	8-12	9-11
	RAI-SH07QHAE	3050-8500	3050-10900	8-12	9-11
	RAS-EH07QHAE	3050-8500	3050-10900	8-12	9-11
	RAS-SH07QHAE	3050-8500	3050-10900	8-12	9-11
	RAD-SH07QHAE	3050-8500	3050-10900	8-12	9-11
9K Btu	RAF-SH09QHAE	3050-10600	3050-15000	11-17	14-18
	RAI-SH09QHAE	3050-10200	3050-18000	11-17	14-18
	RAS-EH09RHAE	3050-10200	3050-18000	11-17	14-18
	RAS-SH09RHAE	3050-10200	3050-18000	11-17	14-18
	RAD-SH09QHAE	3050-10200	3050-18000	11-17	14-18
12K Btu	RAF-SH12QHAE	3050-13650	3050-18000	16-24	17-22
	RAI-SH12QHAE	3050-13650	3050-22500	16-24	17-22
	RAS-EH12RHAE	3050-13650	3050-22500	16-24	17-22
	RAS-SH12RHAE	3050-13650	3050-22500	16-24	17-22
	RAD-SH12QHAE	3050-13650	3050-22500	16-24	17-22
18K Btu	RAF-SH18QHAE	3050-17750	3050-27600	23-24	23-29
	RAI-SH18QHAE	4100-19800	4100-23200	23-24	23-29
	RAS-EH18RHAE	4100-19800	4100-23200	23-24	23-29
	RAS-SH18RHAE	4100-19800	4100-23200	23-24	23-29
	RAD-SH18QHAE	4100-19800	4100-23200	23-24	23-29

\*Two, three, four or five indoor units can be installed with one outdoor unit.

\*One-unit values are for one unit operation with two indoors connected.

\*Total nominal cooling capacity should not be more than 36K Btu.



## 4 SOUND DATA

### CONTENTS

<b>4</b>	<b>SOUND DATA</b> _____	<b>4-1</b>
4.1.	SOUND DATA (RAM-S36U4HLAE) _____	4-2



## 4.1 RAM-S24U3HLAE

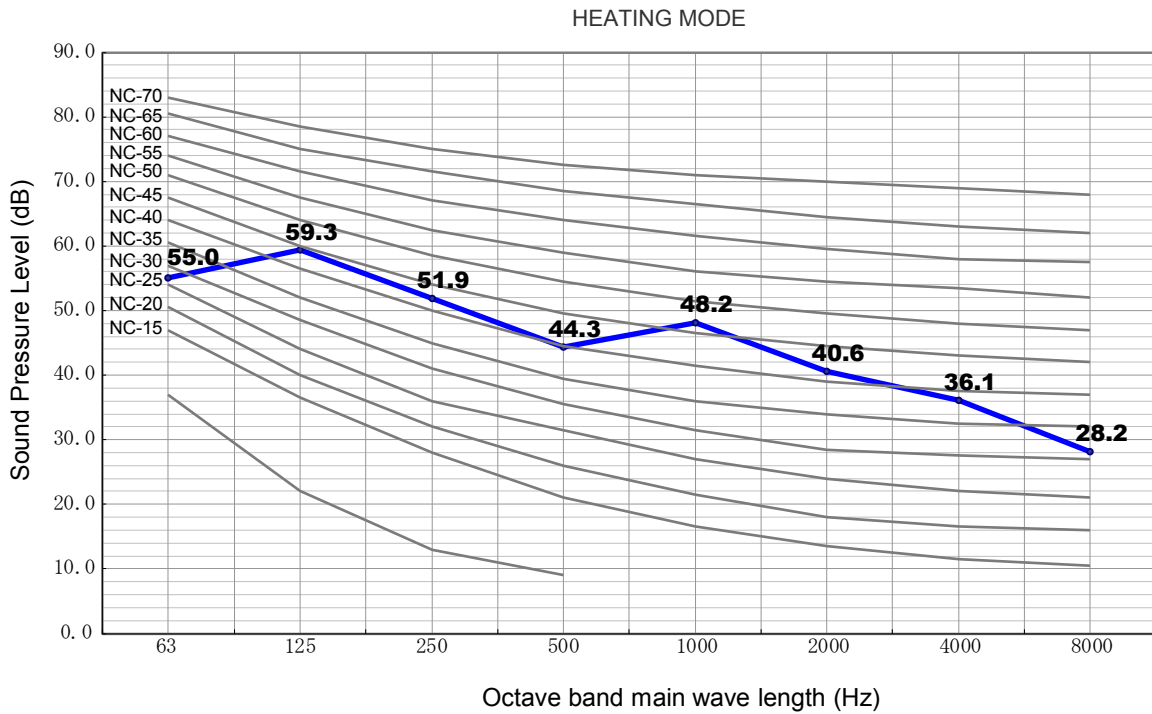
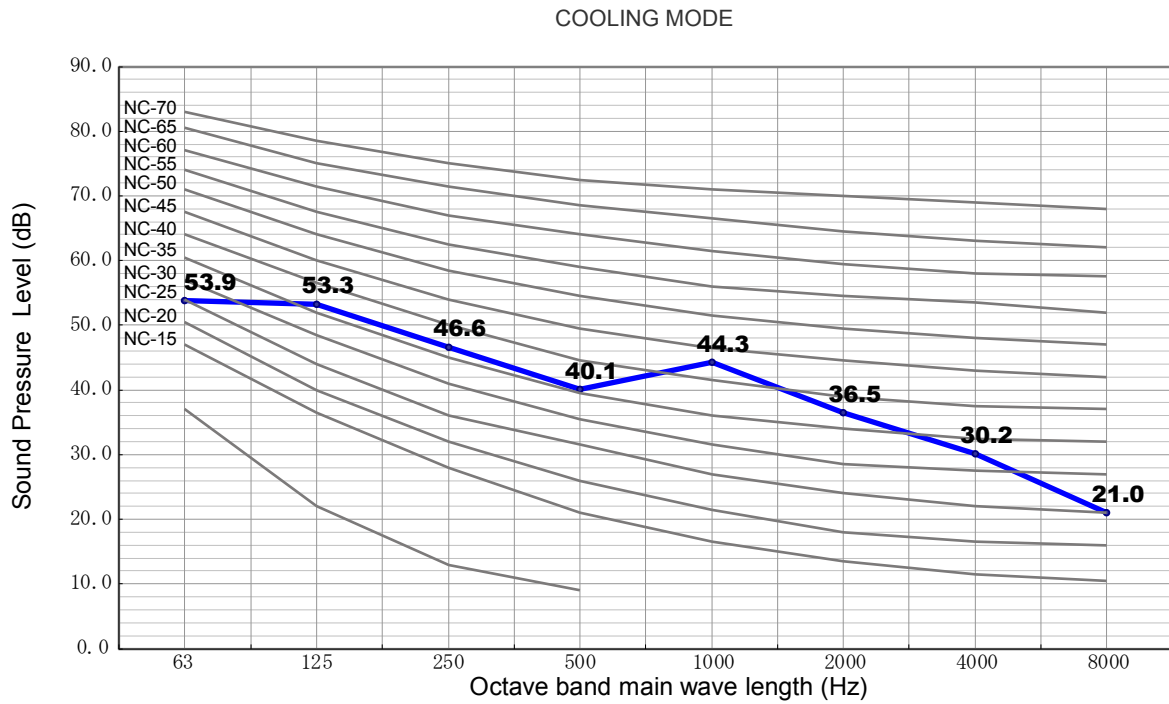

The Sound Pressure Level is based on the following conditions:

1 meter from the unit front surface and 1 meter from floor level

The above data was measured in an anechoic chamber. Please take into consideration reflected sound of your specific site



## 5 WORKING RANGE

### CONTENTS

<b>5</b>	<b>WORKING RANGE</b>	<b>5-1</b>
5.1.	POWER SUPPLY	5-2
5.2.	WORKING RANGE	5-2
5.2.1.	MULTIZONE	5-2



## 5.1. POWER SUPPLY

<b>Working Voltage</b>	198V ~ 264V
<b>Voltage Imbalance</b>	Within a 3% Deviation from Each Voltage at the Main Terminal of Outdoor Unit
<b>Starting Voltage</b>	Higher than 85% of the Rated Voltage

## 5.2. WORKING RANGE

### 5.2.1. MULTIZONE

Applicable models:

<b>MULTIZONE</b>
RAM-S24U3HLAE

The temperature range is indicated in the following table.

#### Cooling

working range	min (°C)	max (°C)	rated (°C)
outdoor	-10	46	35
indoor	16	32	26.67

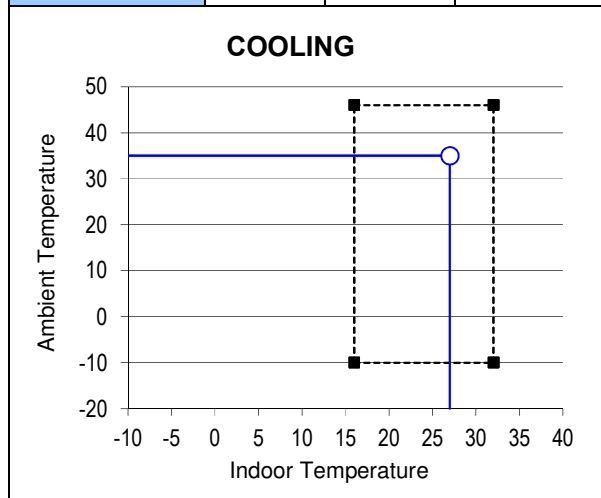

#### Heating

working range	min (°C)	max (°C)	rated (°C)
outdoor	-20	24	8.33
indoor	16	27	21.11

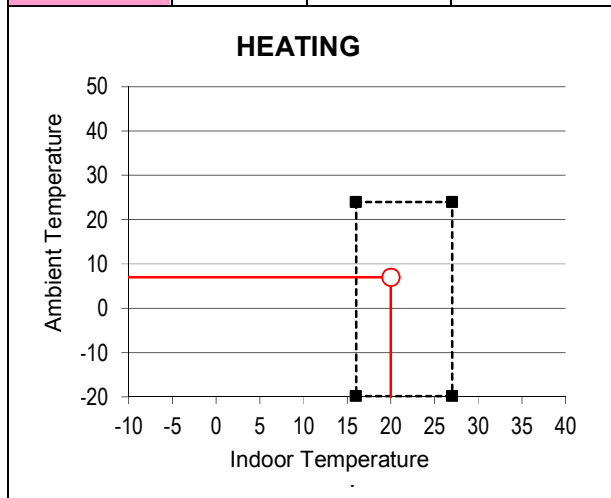



6 ELECTRICAL DATA

CONTENTS

6	ELECTRICAL DATA	6-1
6.1.	INDOOR UNIT	6-2
6.2.	OUTDOOR UNIT	6-3



**6.1. INDOOR UNIT**

Model	Unit Main Power	Rated input current of power conversion equipment	Indoor Fan Motor	
	VOL, PH, Hz		RNC	IPT
RAS-EH07QHAE	208-230, 1, 60	0.45	0.67	38
RAS-EH09RHAE	208-230, 1, 60	0.45	0.67	38
RAS-EH12RHAE	208-230, 1, 60	0.45	0.67	38
RAS-EH18RHAE	208-230, 1, 60	0.45	0.67	38
RAS-SH07QHAE	208-230, 1, 60	0.62	0.67	30
RAS-SH09RHAE	208-230, 1, 60	0.62	0.67	30
RAS-SH12RHAE	208-230, 1, 60	0.62	0.67	30
RAS-SH18RHAE	208-230, 1, 60	0.64	0.16	45
RAF-SH07QHAE	208-230, 1, 60	-	0.75	38
RAF-SH09QHAE	208-230, 1, 60	-	0.75	38
RAF-SH12QHAE	208-230, 1, 60	-	0.75	38
RAF-SH18QHAE	208-230, 1, 60	-	0.75	38
RAI-SH07QHAE	208-230, 1, 60	-	0.25	57
RAI-SH09QHAE	208-230, 1, 60	-	0.25	57
RAI-SH12QHAE	208-230, 1, 60	-	0.25	57
RAI-SH18QHAE	208-230, 1, 60	-	0.25	57
RAD-SH07QHAE	208-230, 1, 60	0.45	0.11	20
RAD-SH09QHAE	208-230, 1, 60	0.45	0.11	20
RAD-SH12QHAE	208-230, 1, 60	0.45	0.11	20
RAD-SH18QHAE	208-230, 1, 60	1.2	0.75	180

VOL: Rated Unit Power Supply Voltage (V)  
 Hz: Frequency (Hz)

RNC: Running Current (A)  
 PH: Phase ( $\phi$ )  
 IPT: Input (W)



## 6.2. OUTDOOR UNIT

Model	Unit Main Power		Electrical Data			
	VOL, PH, Hz	Rated input current of power conversion equipment (A)	Rated Cooling Current	Rated Heating Current	MCA	MOP
RAM-S24U3HLAE	208-230, 1, 60	16	8.39	10.83	21	35

VOL: Rated Unit Power Supply Voltage (V)

HZ: Frequency (Hz)

PH: Phase ( $\phi$ )

MCA: Minimum Circuit Ampacity (A)

MOP: Maximum Overcurrent Protection (A)

- NOTE:** 1. The above compressor data is based on 100% capacity combination of indoor units at the rated operating frequency
2. This data is based on the same conditions as the nominal heating and cooling capacities.
3. The compressor started by an inverter, resulting in extremely low starting current.



## 7 WIRING DIAGRAM

### CONTENTS

<b>7</b>	<b>WIRING DIAGRAM</b>	<b>7-1</b>
7.1.	MULTIZONE	7-2
7.1.1.	RAS-EH07QHLAE, RAS-EH09/12/18RHLAE	7-2
7.1.2.	RAS-SH07QHLAE, RAS-SH09/12RHLAE	7-3
7.1.3.	RAS-SH18RHLAE	7-4
7.1.4.	RAF-SH07/09/12/18QHLAE	7-5
7.1.5.	RAI- SH07/09/12/18QHLAE	7-6
7.1.6.	RAD-SH07/09/12QHLAE	7-7
7.1.7.	RAD-SH18QHLAE	7-8
7.2	RAM-S24U3HLAE	7-9



## 7.1. MULTIZONE

## 7.1.1. RAS-EH07QHAE, RAS-EH09/12/18RHAE

BLU : BLUE  
 GRY : GRAY  
 BLK : BLACK

YEL : YELLOW  
 ORN : ORANGE  
 PNK : PINK

BRN : BROWN  
 GRN : GREEN  
 VIO : VIOLET

WHT : WHITE  
 RED : RED  
 IVO : IVORY

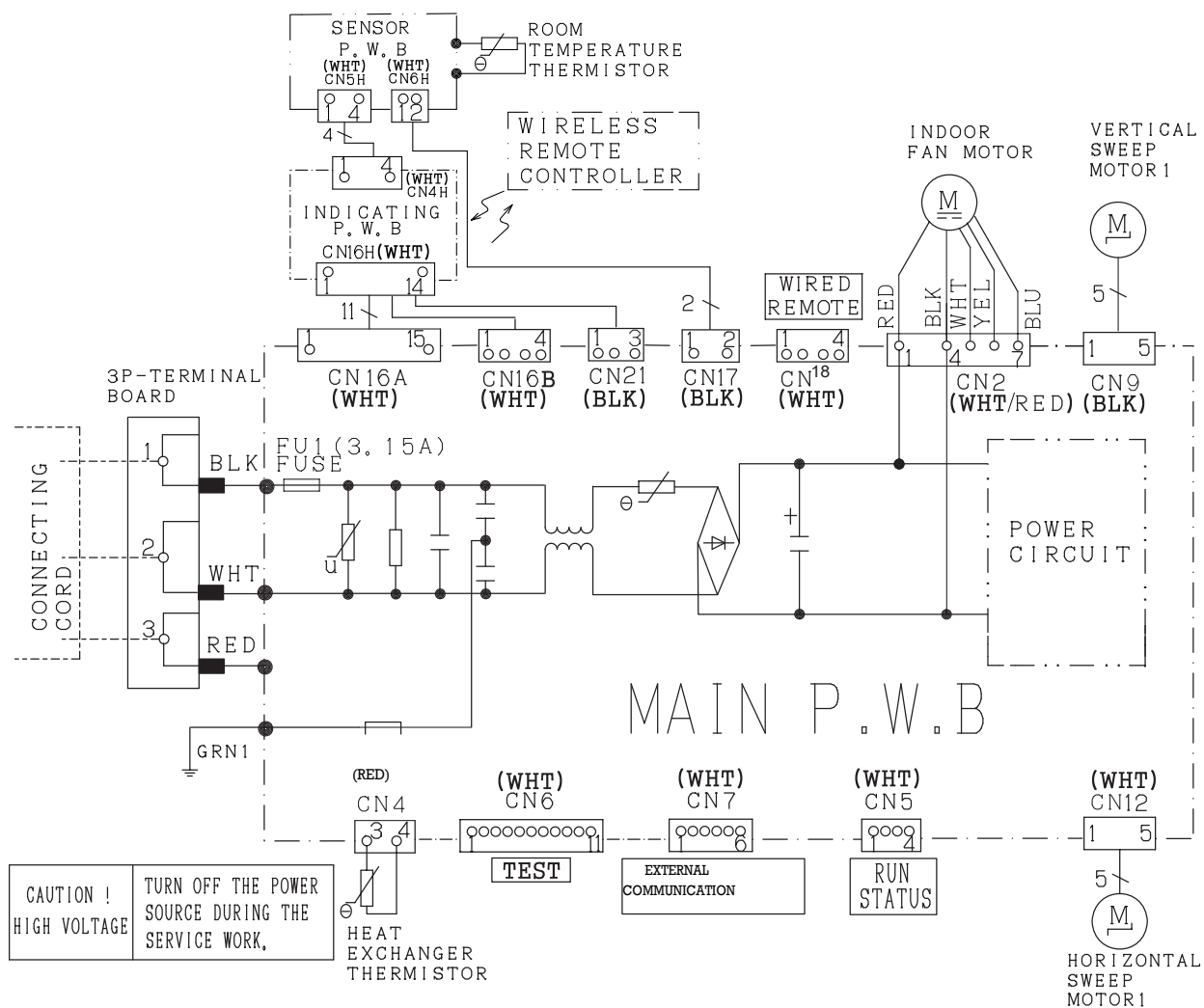



## 7.1.2. RAS-SH07QHLAE, RAS-SH09/12RHLAE

BLU : BLUE  
 GRY : GRAY  
 BLK : BLACK

YEL : YELLOW  
 ORN : ORANGE  
 PNK : PINK

BRN : BROWN  
 GRN : GREEN  
 VIO : VIOLET

WHT : WHITE  
 RED : RED  
 IVO : IVORY

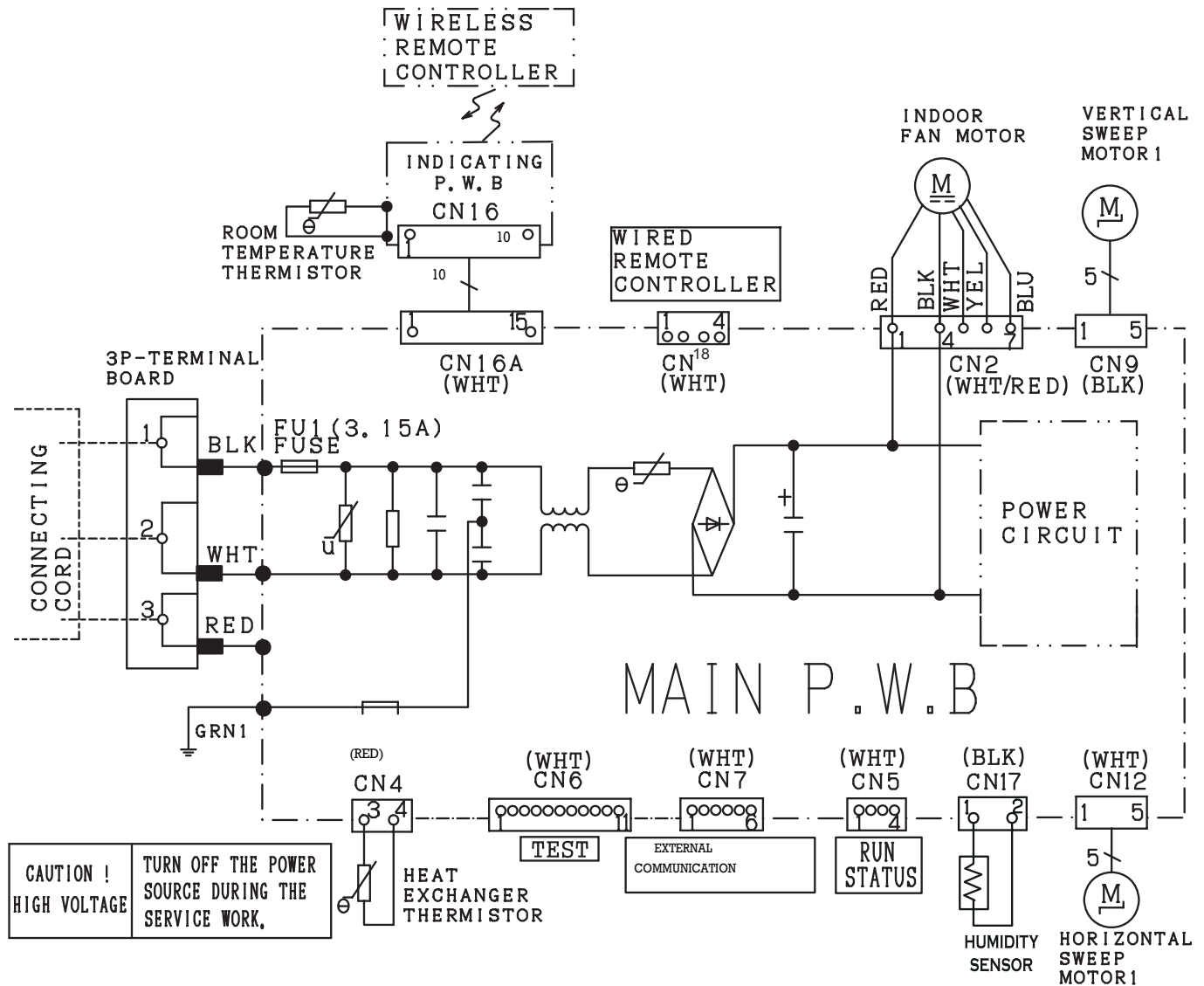



## 7.1.3. RAS-SH18RHLAE

BLU : BLUE  
 GRY : GRAY  
 BLK : BLACK

YEL : YELLOW  
 ORN : ORANGE  
 PNK : PINK

BRN : BROWN  
 GRN : GREEN  
 VIO : VIOLET

WHT : WHITE  
 RED : RED  
 IVO : IVORY

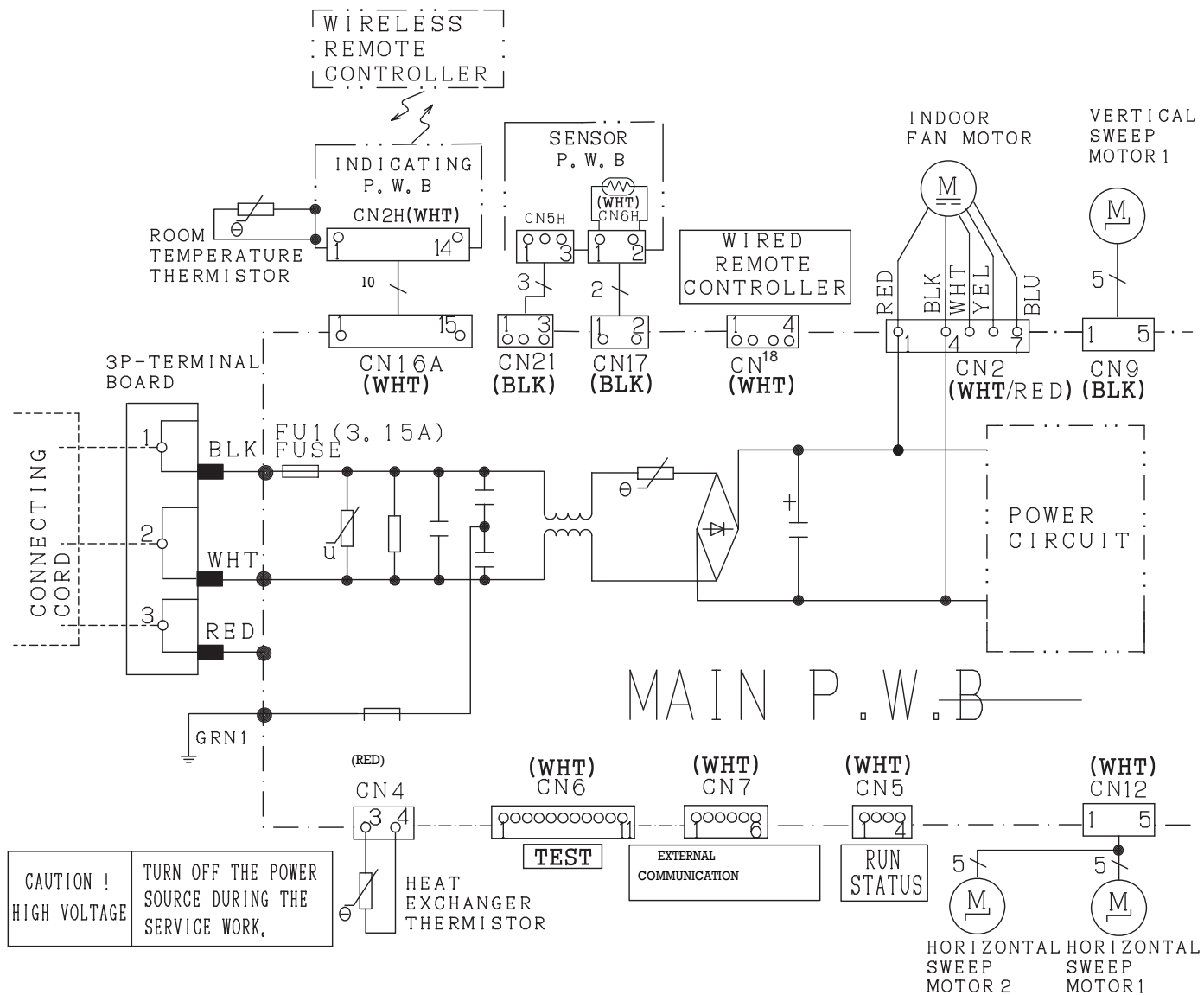



## 7.1.4. RAF-SH07QHLAE, RAF-SH09QHLAE, RAF-SH12QHLAE, RAF-SH18QHLAE

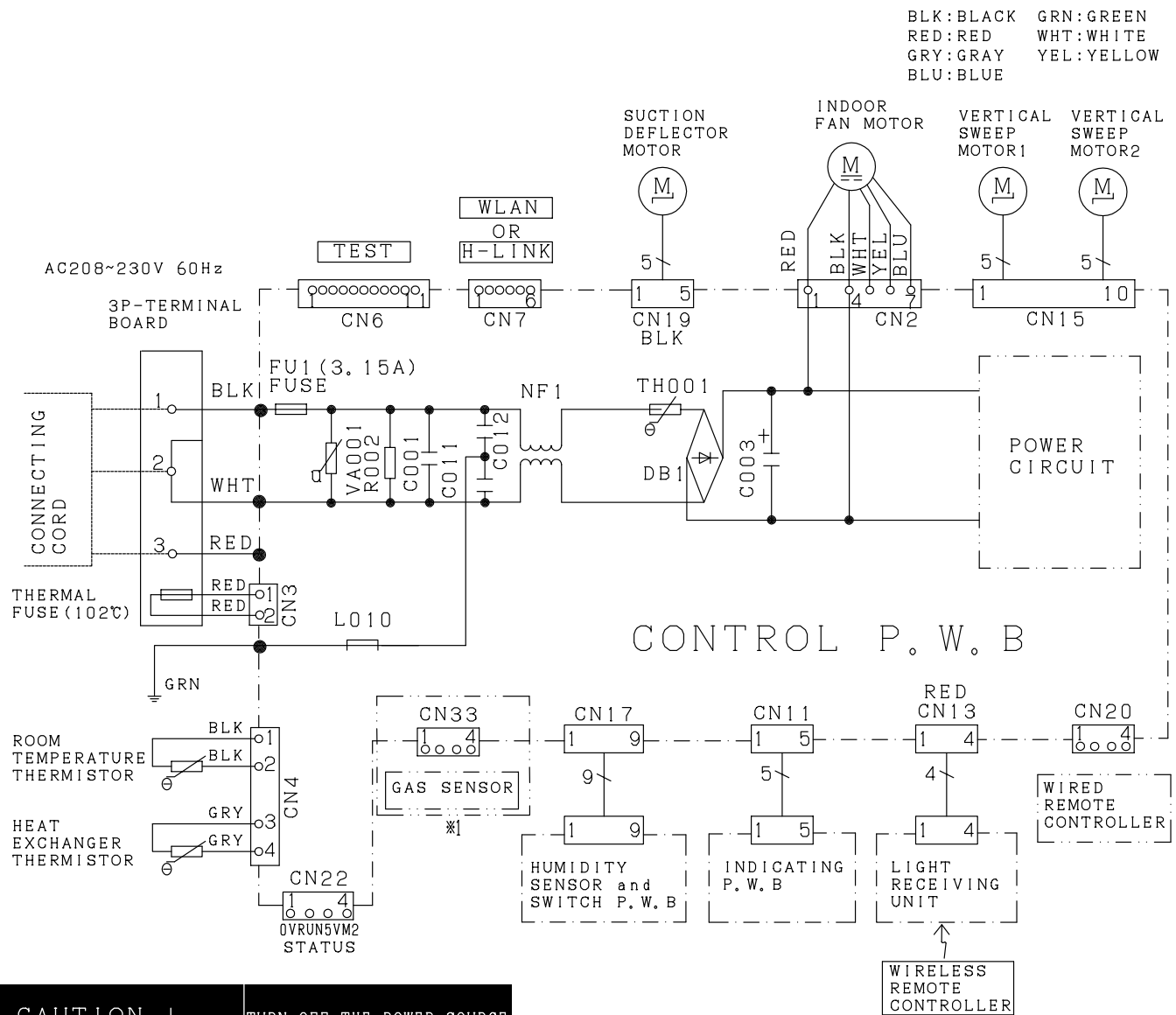



## 7.1.5. RAI-SH07QHLAE, RAI-SH09QHLAE, RAI-SH12QHLAE, RAI-SH18QHLAE

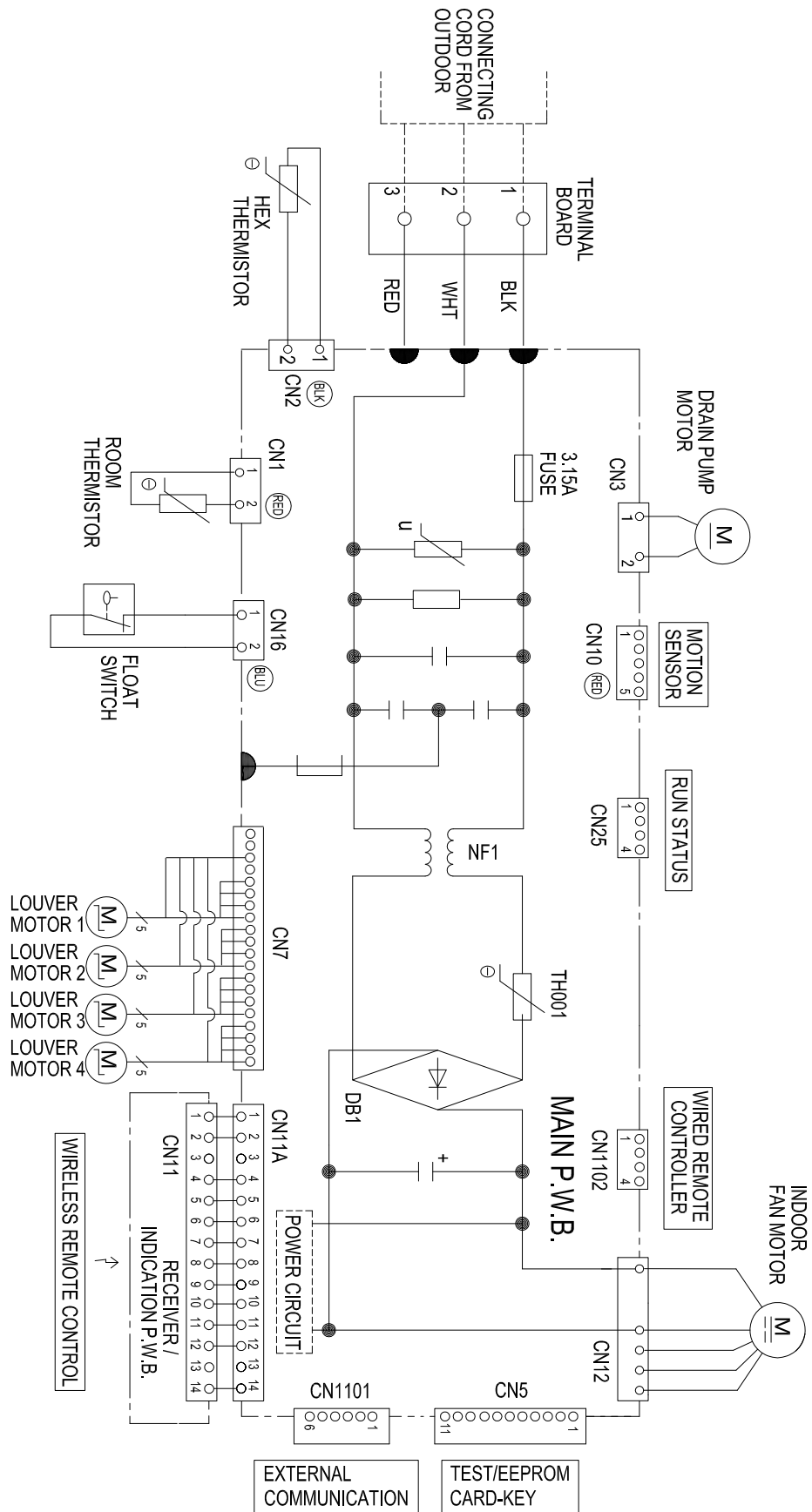



7.1.6. RAD-SH07QHLAE, RAD-SH09QHLAE, RAD-SH12QHLAE

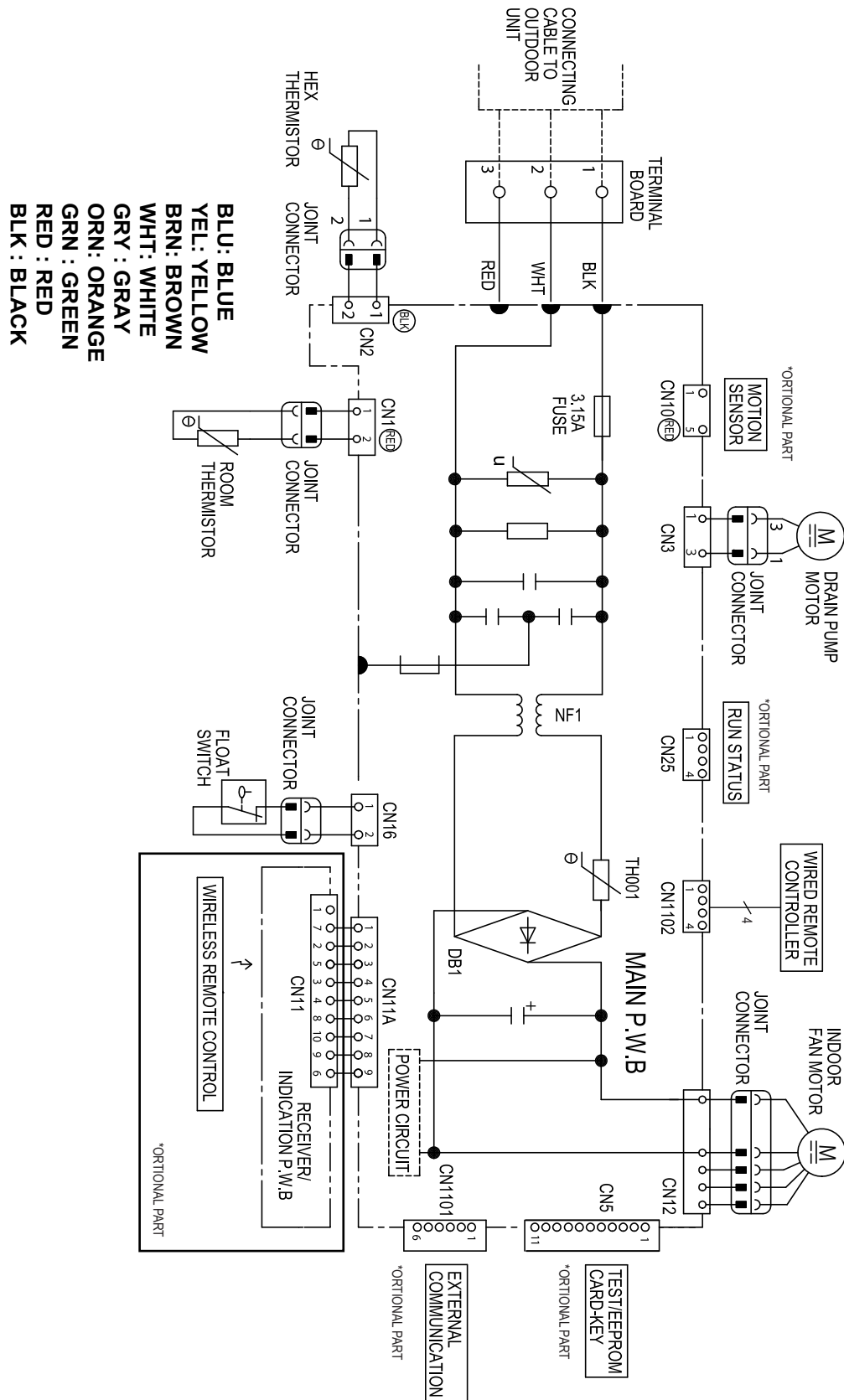



7.1.7. RAD-SH18QHLAE

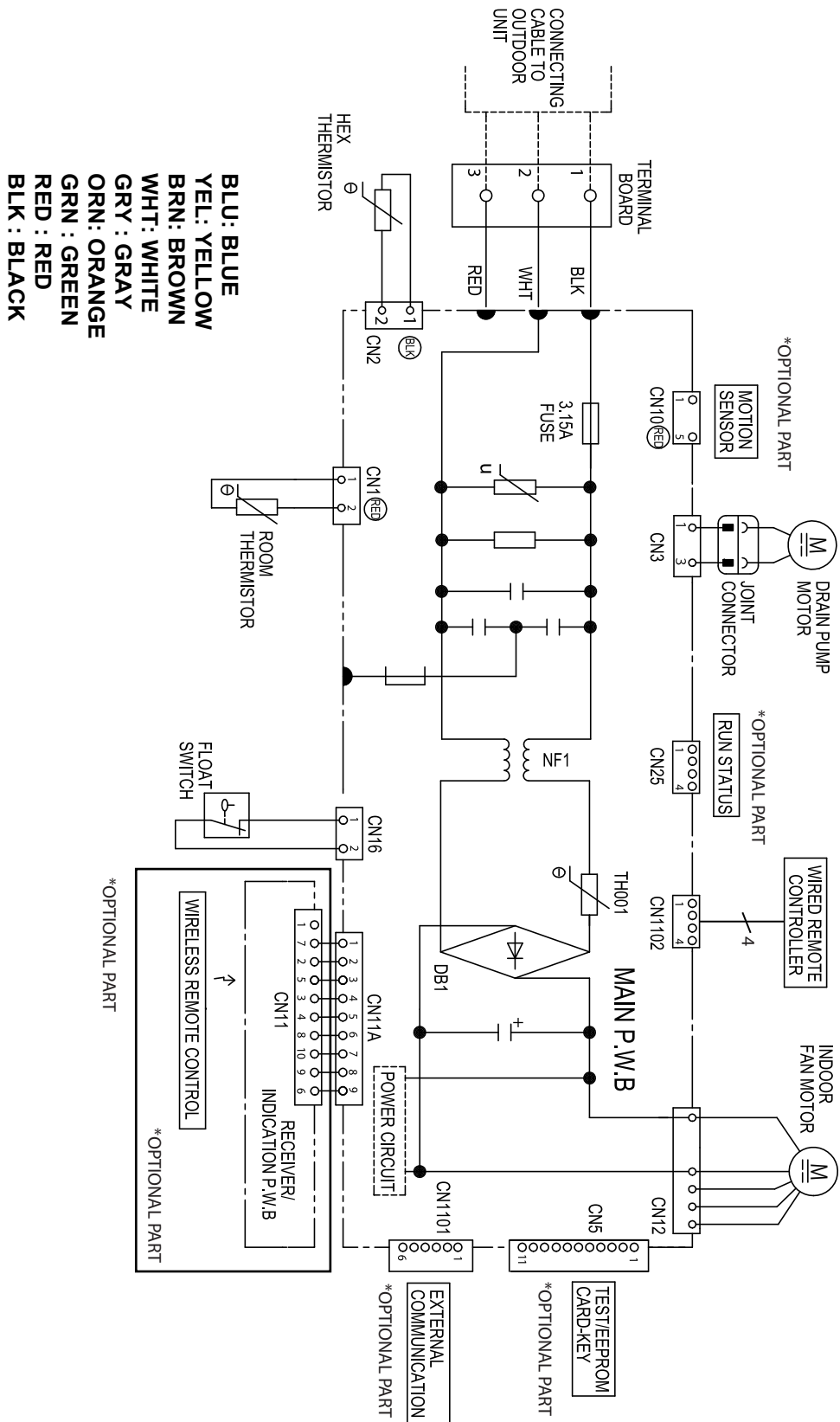



## 7.2 RAM-S24U3HLAE

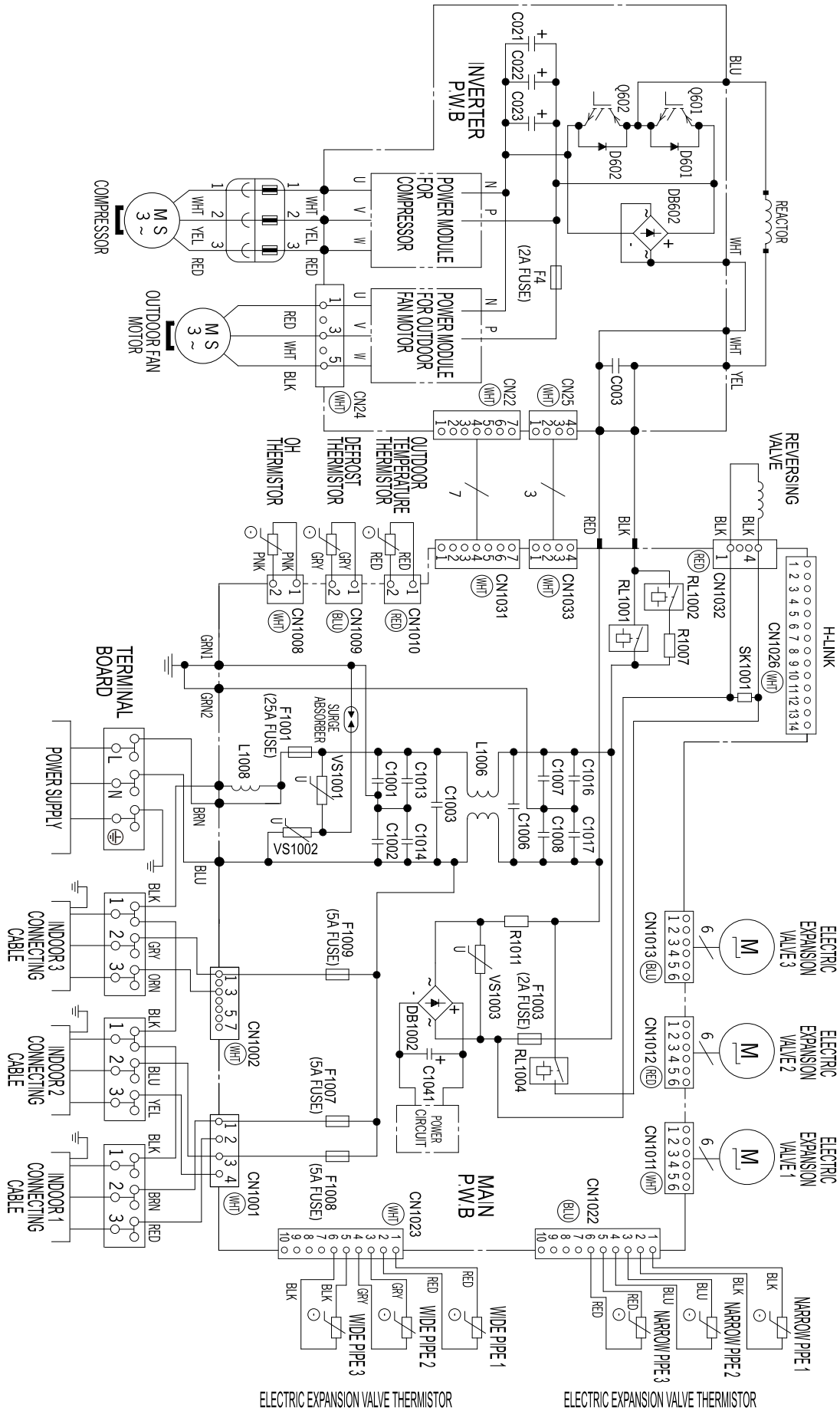



## 8 REFRIGERANT CYCLE

### CONTENT

<b>8</b>	<b>REFRIGERANT CYCLE</b>	<b>8-1</b>
8.1.	MULTIZONE INDOOR UNITS	8-2
8.1.1.	WALL TYPE (RAS-EH07QHLAE, RAS-EH09/12RHLAE)	8-2
8.1.2.	WALL TYPE (RAS-EH18RHLAE)	8-3
8.1.3.	WALL TYPE (RAS-SH07QHLAE, RAS-SH09/12RHLAE)	8-4
8.1.4.	WALL TYPE (RAS-SH18RHLAE)	8-5
8.1.5.	FLOOR TYPE (RAF-SH07/09/12QHLAE)	8-6
8.1.6.	FLOOR TYPE (RAF-SH18QHLAE)	8-7
8.1.7.	CEILING CASSETTE (RAI- SH07/09/12/18QHLAE)	8-8
8.1.8.	DUCT TYPE (RAD-SH07/09/12QHLAE)	8-9
8.1.9.	DUCT TYPE (RAD-SH18QHLAE)	8-10
8.2.	MULTIZONE OUTDOOR UNITS (RAM-S24U3HLAE)	8-11



## 8.1. MULTIZONE INDOOR UNITS

### 8.1.1. WALL TYPE: RAS-EH07QHLAE, RAS-EH09/12RHLAE

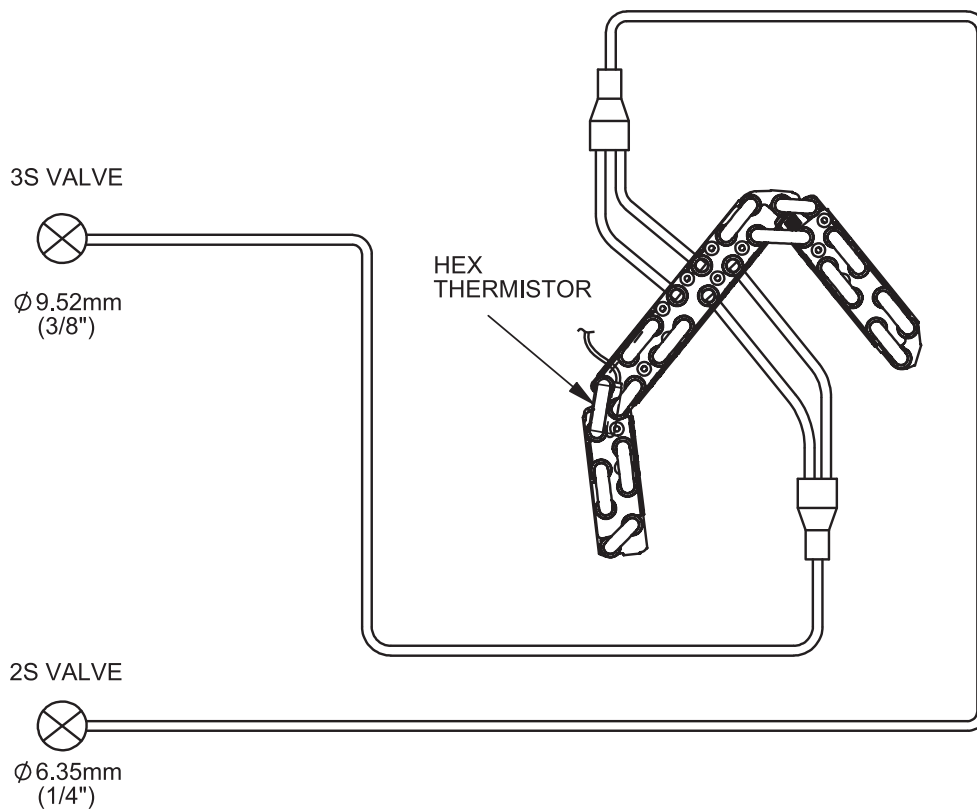



## 8.1.2. WALL TYPE: RAS-EH18RHLAE

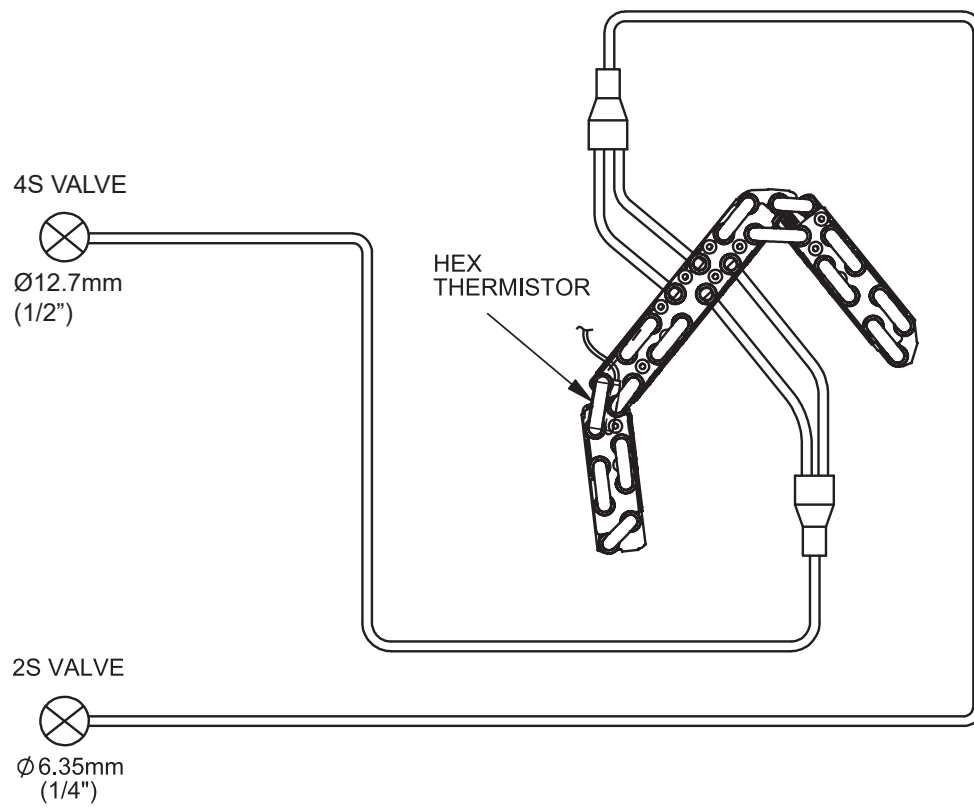



## 8.1.3. WALL TYPE: RAS-SH07QHLAE, RAS-SH09/12RHLAE

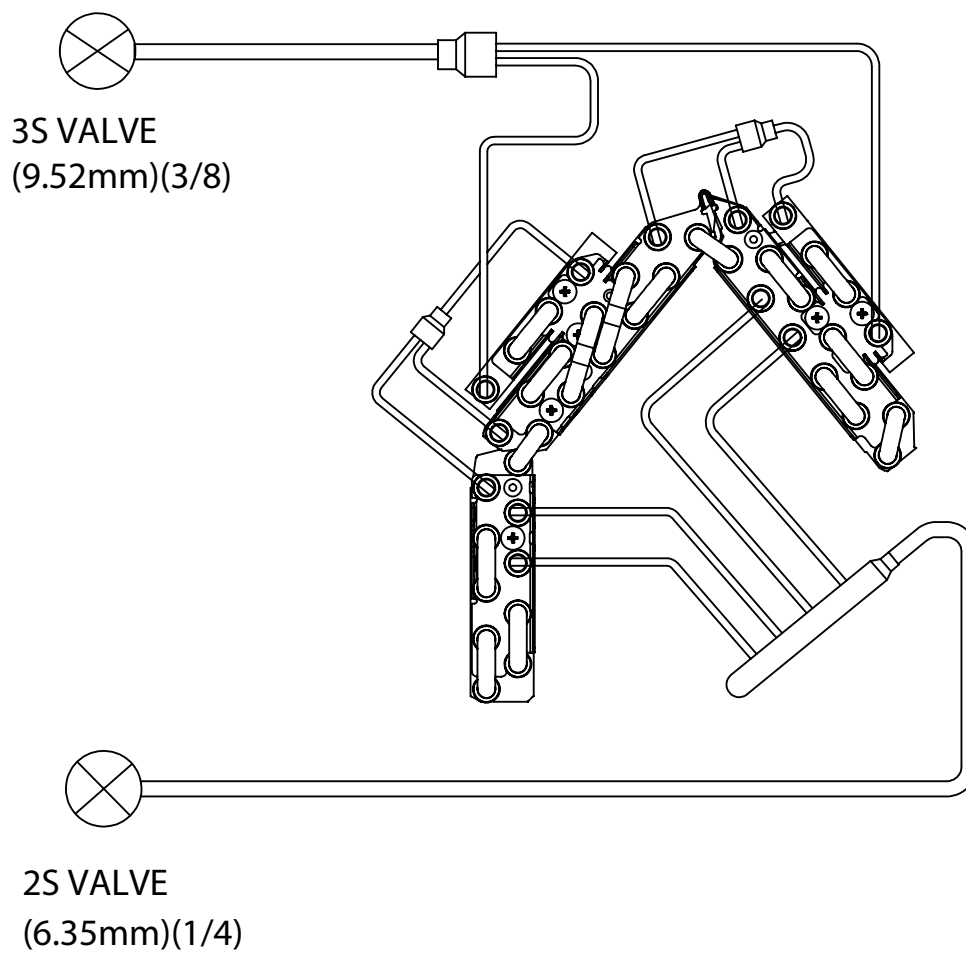



## 8.1.4. WALL TYPE: RAS-SH18RHLAE

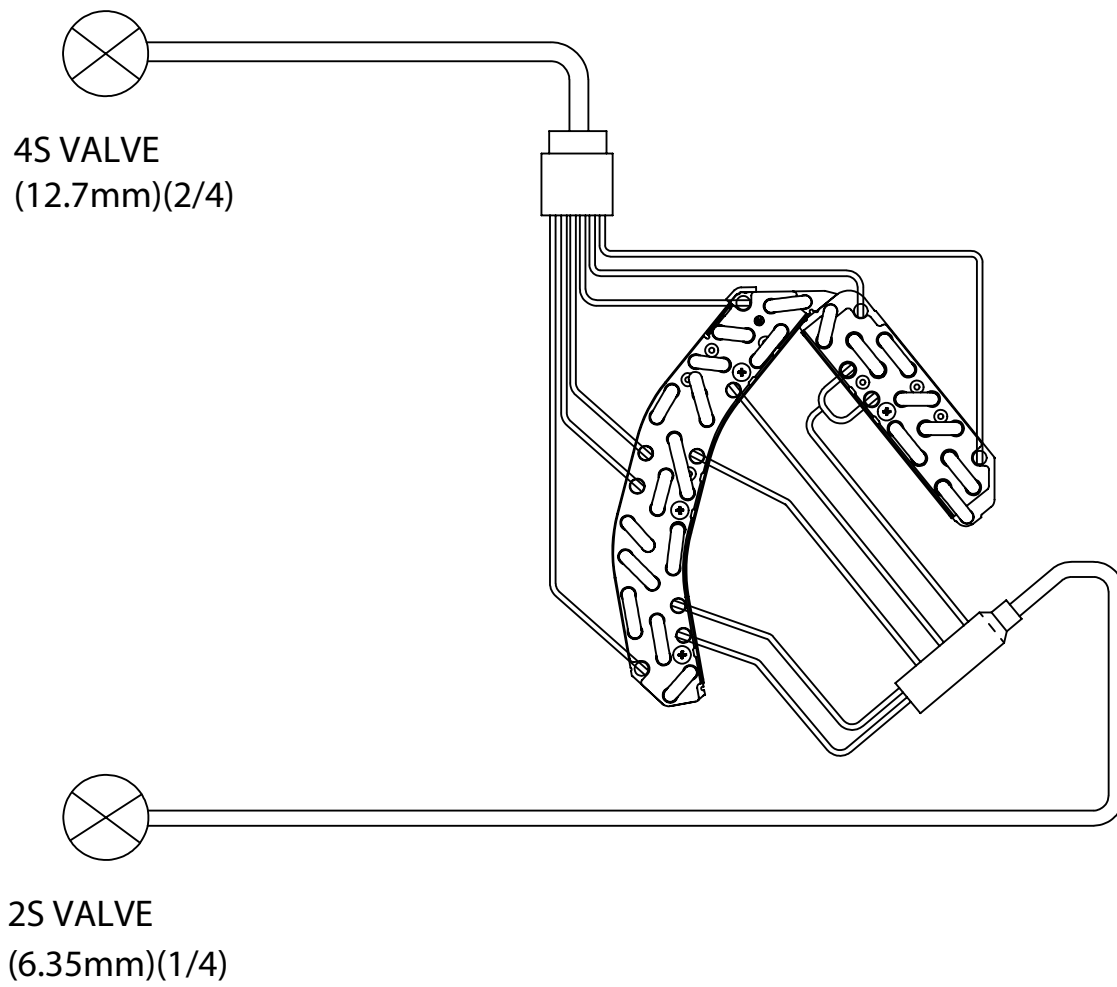

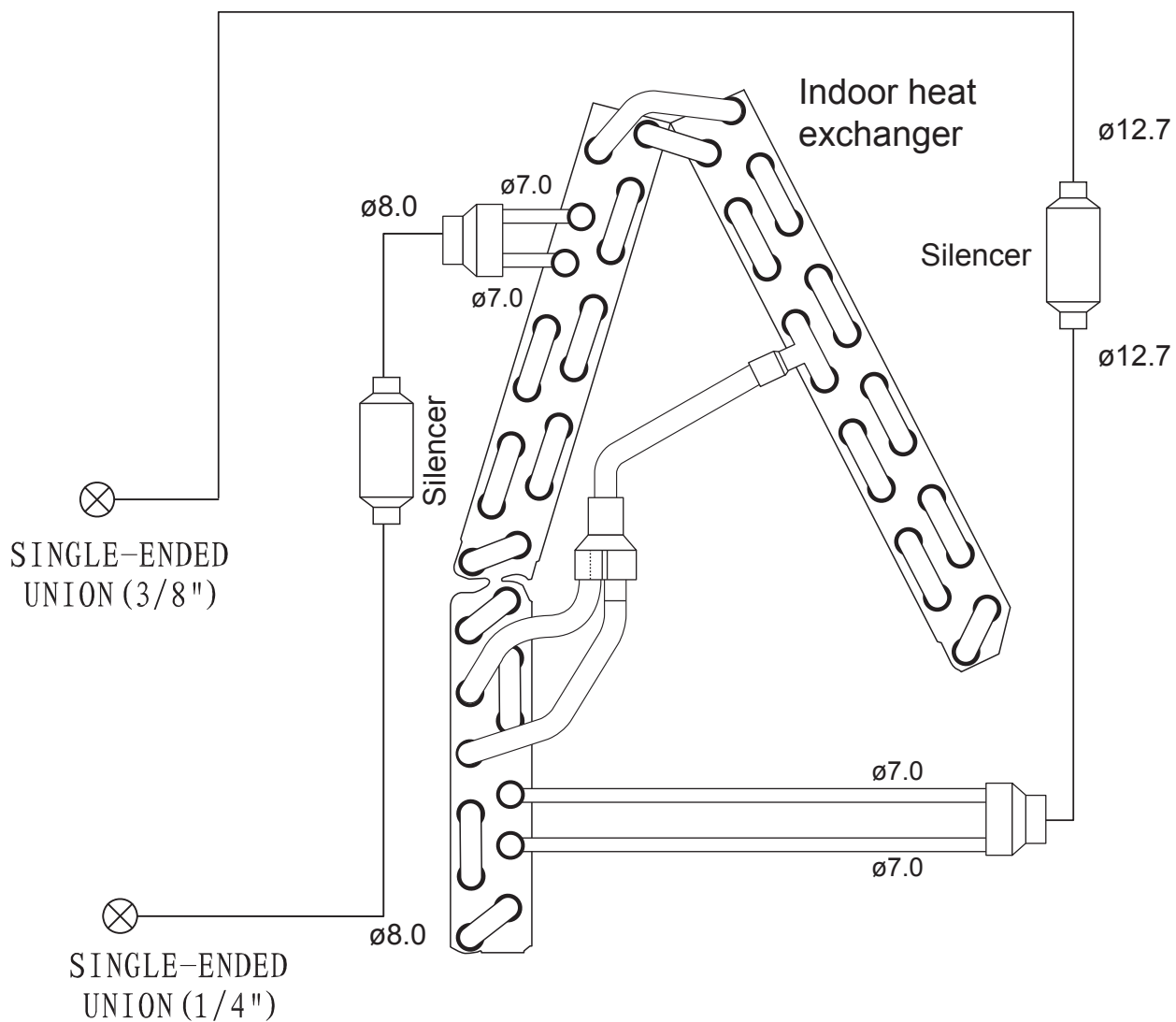

**8.1.5. FLOOR TYPE: RAF-SH07QHLAE, RAF-SH09QHLAE, RAF-SH12QHLAE**



## 8.1.6. FLOOR TYPE: RAF-SH18QHLAE

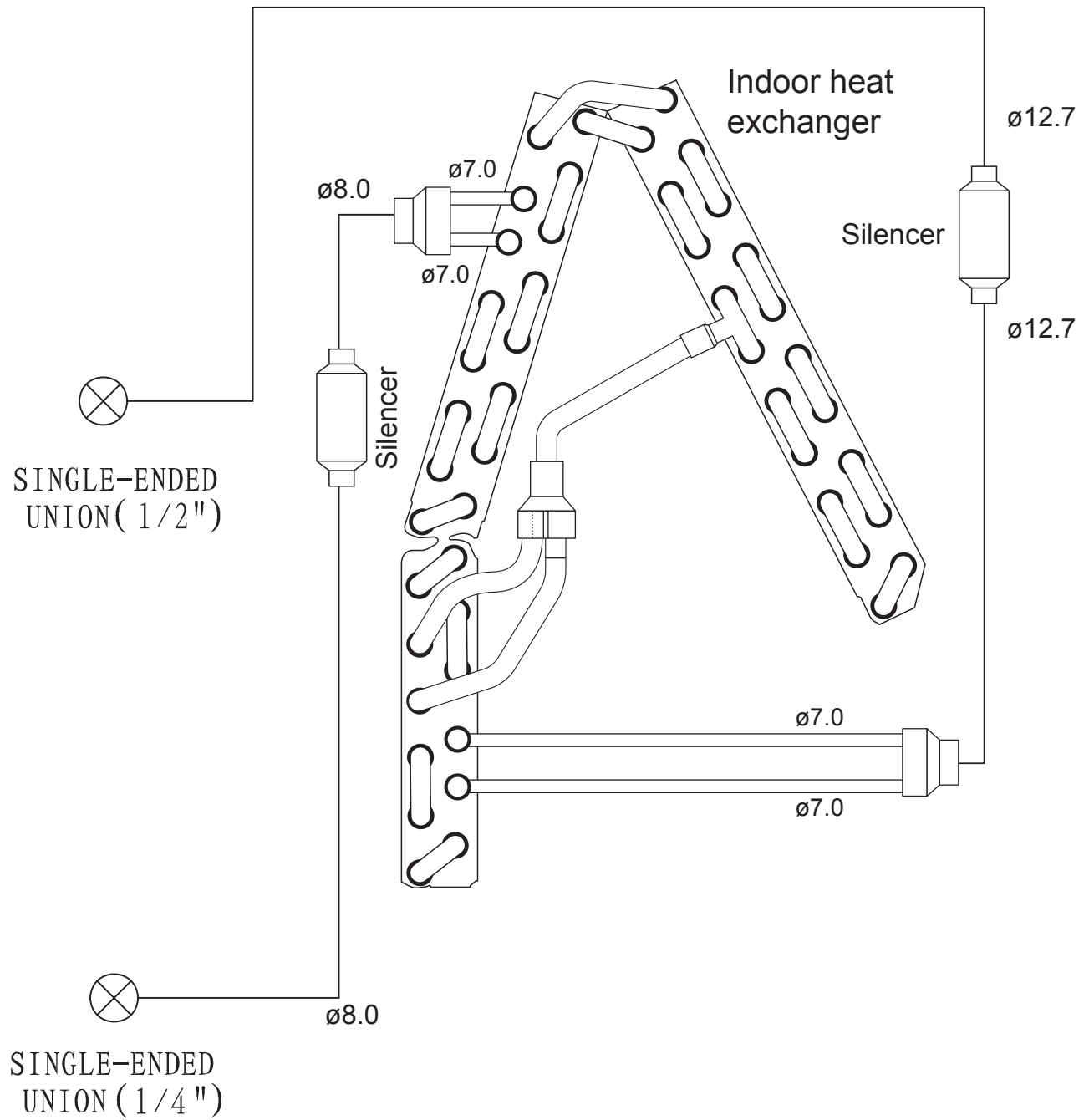



## 8.1.7. CEILING CASSETTE: RAI-SH07QHLAE, RAI-SH09QHLAE, RAI-SH12QHLAE, RAI-SH18QHLAE

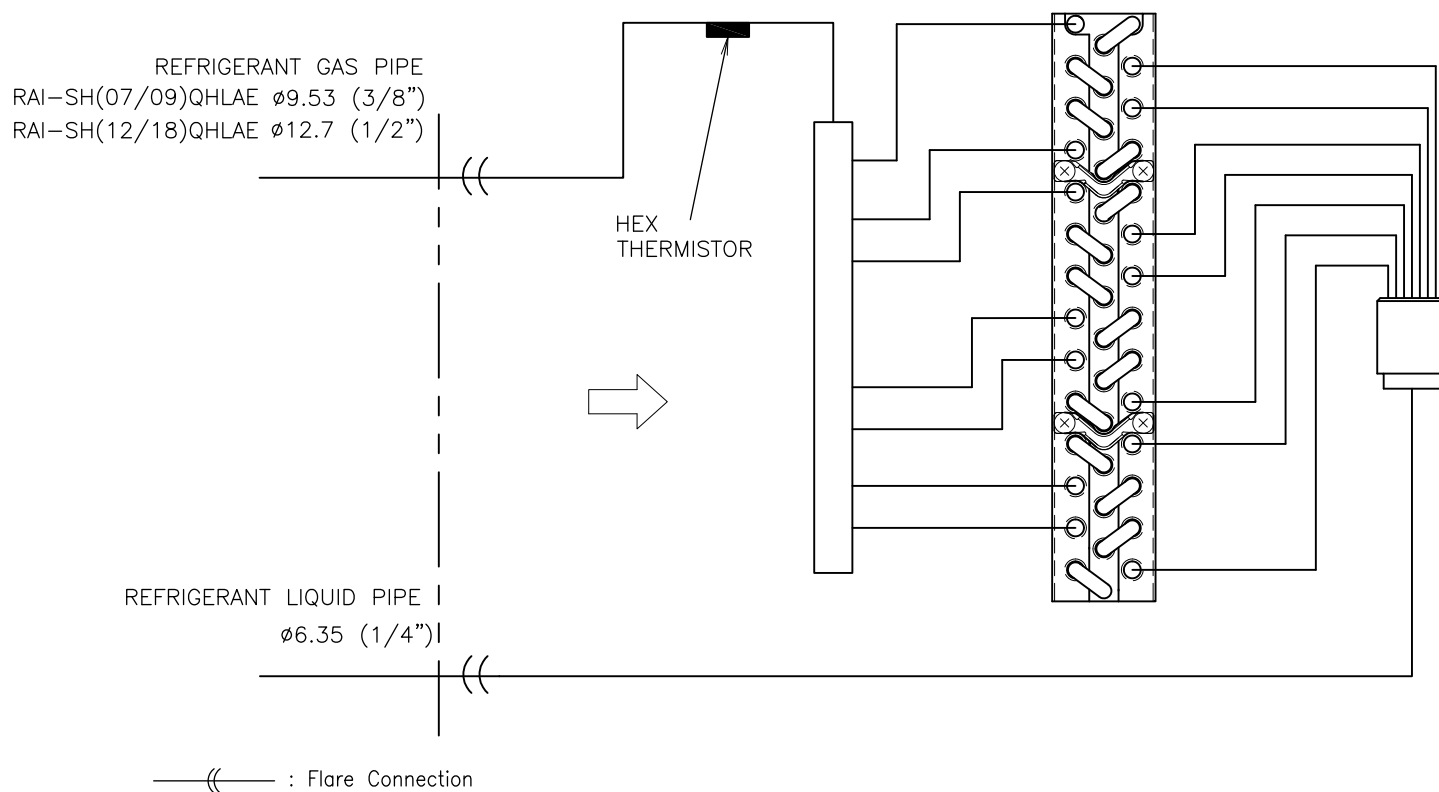



## 8.1.8. DUCT TYPE: RAD-SH07QHLAE, RAD-SH09QHLAE, RAD-SH12QHLAE

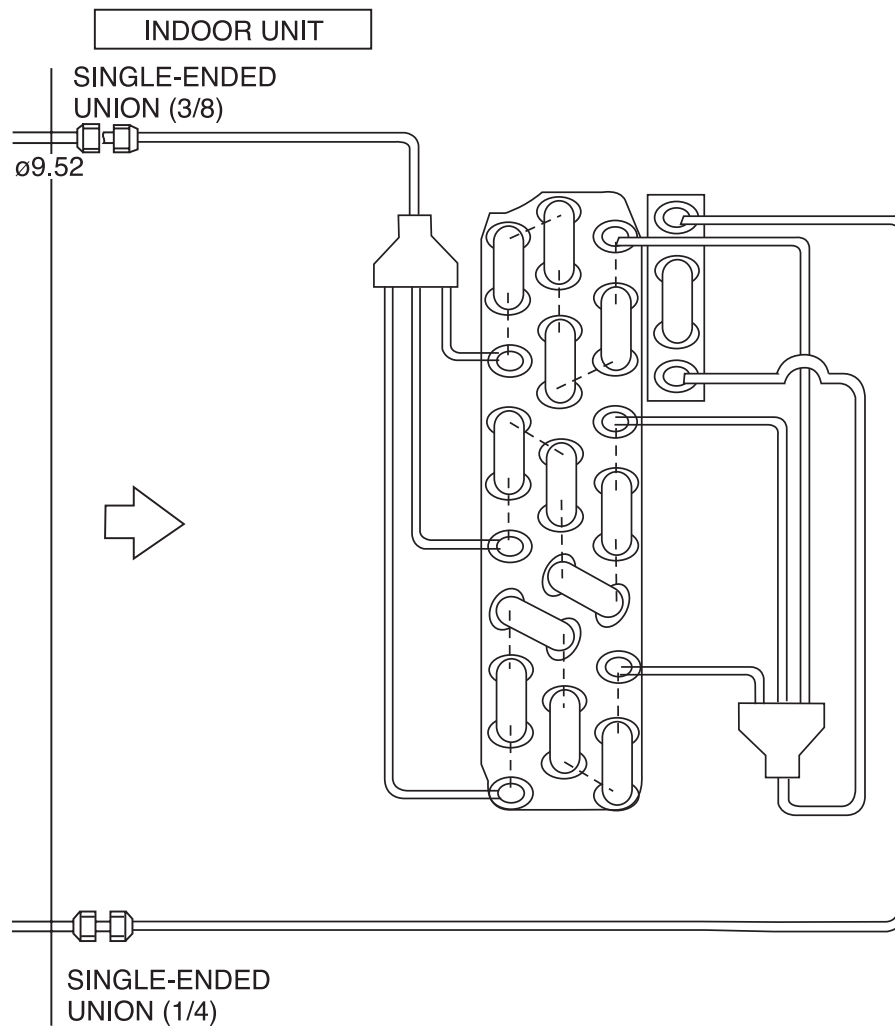



8.1.9. DUCT TYPE: RAD-SH18QHLAE

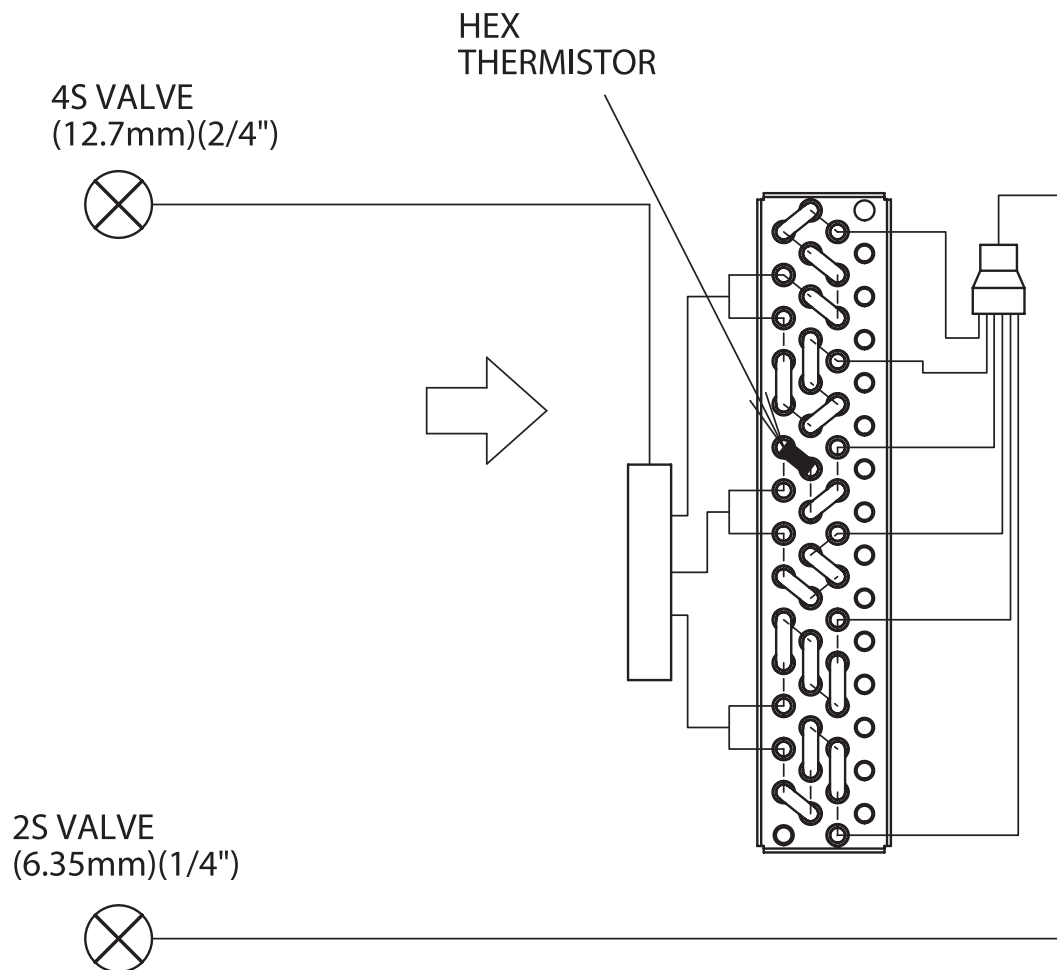



## 8.2 3 ROOMS MULTIZONE: RAM-S24U3HLAE

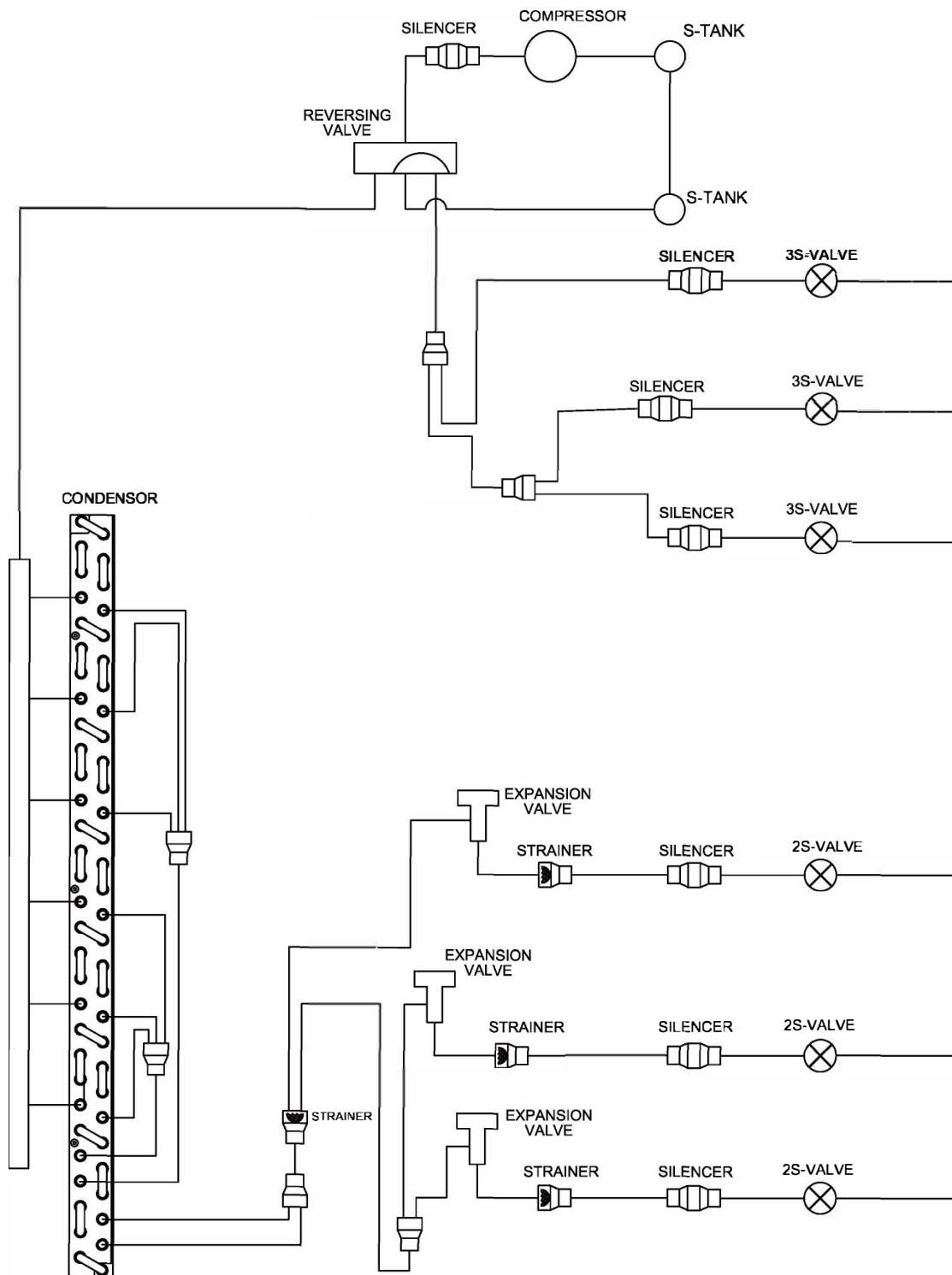



## 9 CONTROL AND FUNCTION

### CONTENTS







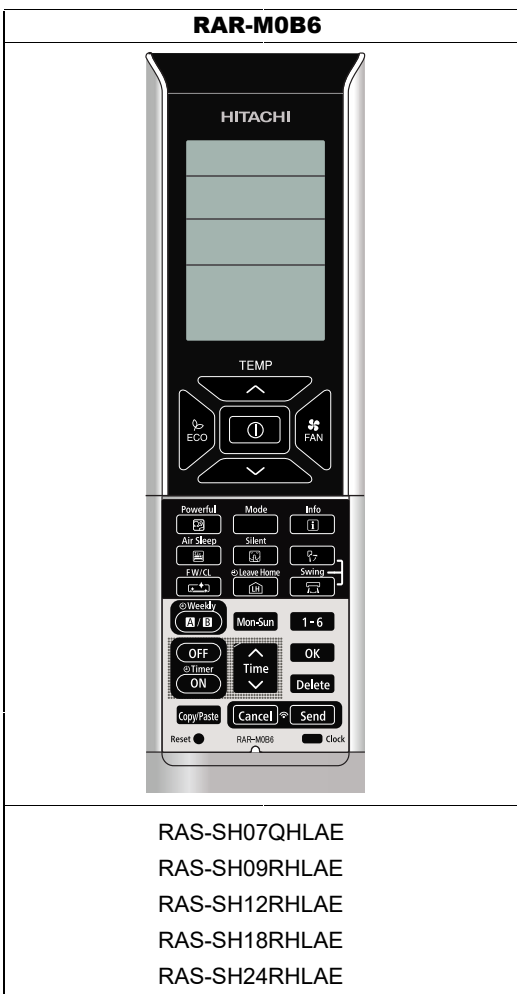

<b>9</b>	<b>CONTROL AND FUNCTION</b>	<b>9-1</b>
9.1.	WIRELESS REMOTE CONTROL FUNCTION	9-2
9.1.1.	RAR-M0B3, RAR-M0B4, RAR-M0B5 AND RAR-M0B6	9-2
9.2.	SHIFT VALUE	9-3
9.3.	OPERATION LOCK	9-5
9.4.	SETTING THE PREVENTION OF MUTUAL INTERFERENCE	9-6
9.5.	INTERMITTENT FAN SPEED SETTING	9-6
9.6.	FAN SPEED SETTING IN THERMO OFF IN COOLING	9-7
9.7.	ERROR CODE INFORMATION	9-8
9.8.	ADDITIONAL FUNCTION VIA DIP-SWITCH SETTINGS	9-10
9.8.1.	AUTO RESTART FUNCTION	9-10
9.8.2.	HEATING/COOLING ONLY MODE SELECTION	9-10
9.9.	WIRELESS REMOTE CONTROL FUNCTION	9-11
9.10.	SHIFT VALUE	9-13
9.11.	DISPLAY OPERATION MODE SETTING	9-14
9.12.	HOW TO CHANGE THE INTERMITTENT FAN CONTROL SETTING	9-15
9.13.	HOW TO CHANGE THE FAN SPEED IN COOLING MODE DURING THERMO OFF	9-16
9.14.	SETTING THE PREVENTION OF MUTUAL INTERFERENCE	9-17



## 9.1 WIRELESS REMOTE CONTROL FUNCTION

### RAR-M0B6



BUTTONS	FUNCTION
	<b>MODE Selector</b> Use this button to select the operating mode. Every time you press this button, the mode will change from (AUTO) → (HEAT) → (DEHUMIDIFY) → (COOL) and (FAN) cyclically.
 FAN	<b>FAN SPEED Selector Button</b> This determines the fan speed. Every time you press this button, the airflow rate will change from (AUTO) → (HIGH) → (MED) → (LOW) → (SILENT) (This button allows selection of optimal or preferred fan speed for each operation mode).
	<b>START/STOP button</b> Press this button to start operation. Press it again to stop operation.
 ECO	<b>ECO button</b> Use this button to set the ECO mode.
	<b>POWERFUL button</b> Use this button to set the POWERFUL mode.
	<b>SILENT button</b> Use this button to set the SILENT mode.
	<b>INFO button</b> 1) Press this button to display temperature for 10 seconds. 2) Press this button to check monthly power consumption. 3) Press this button to receive the current calendar and clock.
	<b>ECO SLEEP TIMER button</b> Use this button to set the ECO sleep timer.
	<b>AUTO SWING (Vertical) button</b> Controls the angle of the horizontal air deflector.



	<b>AUTO SWING (Horizontal) button</b> Controls the angle of the vertical air deflector.
	<b>LEAVE HOME button</b> Prevent the room temperature from falling too much by setting temperature 50°F~60°F when no one is at home.
	<b>FROST WASH / CLEAN button</b> The dust and dirt adhering to indoor heat exchanger which is the cause of the smell. They are washed away by freezing and thawing of the heat exchanger.
<b>WEEKLY TIMER buttons</b>	
	<b>ON/OFF TIMER button</b> The device will turn on (off) and off (on) at the designated time.
	<b>TIME button</b> Press the button to set starting time of the program
<b>OK</b>	<b>OK button</b> Press the button to save the program. The button shall be pressed everytime after finishing a program setting.
<b>Delete</b>	<b>DELETE button</b> 1) Press the button to delete the selected program. 2) Press the button for about 10 seconds by directing the remote controller towards the indoor unit while Mode A or B display blinks, programs for Mode A or B will be deleted both from the indoor unit and the remote controller after the beep sound from the indoor unit.
<b>Mon-Sun</b>	<b>DAY button</b> Select the desired day of the week.
<b>1 - 6</b>	<b>PROGRAM NO. button</b> Press this button to select a program number.
<b>Cancel</b>	<b>CANCEL</b> 1) Press the button to cancel the current setting process on the screen. 2) Press the button by directing the remote controller towards the indoor unit, then weekly timer setting will be canceled from indoor unit after the beep sound from the indoor unit. The program setting remains in the remote controller.
<b>Send</b>	<b>SEND button</b> Press the button for about 3 seconds by directing the remote controller towards the indoor unit after finishing the program setting. Timer lamp on the indoor unit will blink rapidly and after the beep sound from indoor unit, TIMER lamp will light up.
Clock	<b>CLOCK button</b> Press the button to set calendar and clock.
	<b>WEEKLY TIMER MODE button</b> 1) Select Mode A or Mode B. 2 modes can be set and stored as a weekly timer. 2) By pressing the button longer than 3 seconds, program setting screen will appear.

## 9.2 SHIFT VALUE

- Press and hold (START/STOP) button and (ON) button.
- Press [RESET] button on the same time. Release [RESET] button only, then release (START/STOP) and (ON) button once Screen 1 appears.

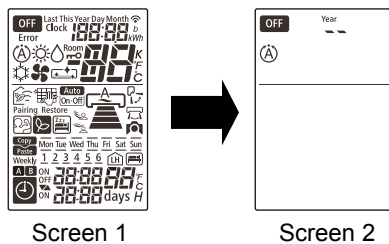

- Press the (MODE) button to display fan mode (Screen 3).

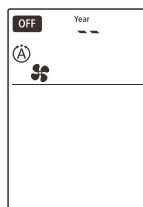



4. Press  (START/STOP) and Screen 4 appear.

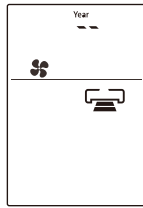



Screen 4

5. Select  (FAN SPEED) button to choose Heating Shift or Cooling Shift Mode (Screen 5).

By setting fan speed to HIGH  or MED  , it will go to Cooling Shift mode.

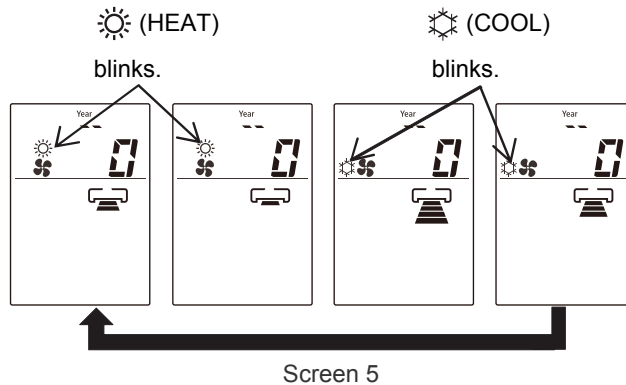

By setting fan speed to LOW  or SILENT  , it will go to Heating Shift mode.

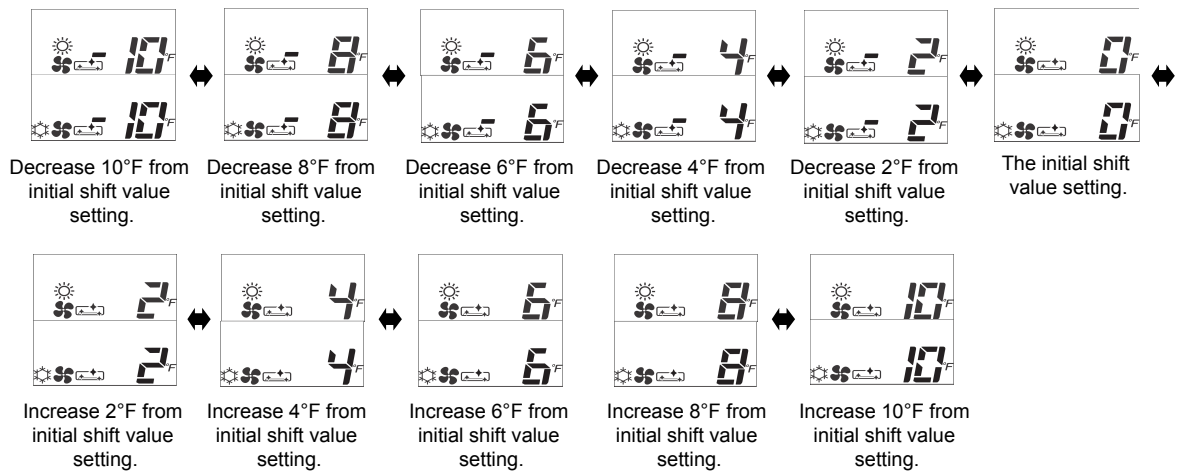

6. Press the Temperature button (  or  ) to adjust the shift value.





#### NOTE:

1. There are total of 11 shift values ranging from -10 to 10.
2. The displayed shift value,  (HEAT) and  (COOL) symbol on the remote controller display will disappear after 10 seconds
3. The changed shift value will remain unchanged after turned off the power.
4. If "0" is displayed on the remote controller display, it indicates the shift value is now at the initial setting.



## 9.3 OPERATION LOCK

### 1. HEATING MODE

- a) Press and hold  (ECO) and  (POWERFUL) buttons, press  (RESET) button on the same time. Release  (RESET) button only when Screen 1 appear, then release  (ECO) button and  (POWERFUL) button.

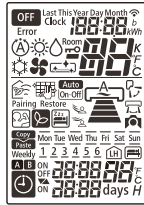

Screen 1



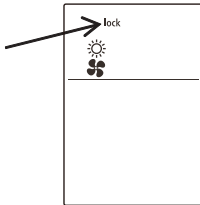

- b) Wait until only Screen 2 appear.



Screen 2

- c) The heating mode operation is locked.  
 d) To unlock HEATING mode, repeat step (a). After all operations mode symbols displayed for 10 seconds, the operation mode symbol before cancellation will be display. The heating mode operation is unlocked.

### 2. COOLING AND DEHUMIDIFYING MODE

- a) Press and hold  (ECO) and  (SILENT) buttons for at least 5 seconds when the remote controller is OFF.  
 b) Wait until only  and  displayed on the screen. The cooling and dehumidifying modes operation is locked.  
 c) To unlock HEATING mode, repeat step (a). After all operations mode symbols displayed for 10 seconds, the operation mode symbol before cancellation will be display. The cooling and dehumidifying mode operation is unlocked.



## 9.4 SETTING THE PREVENTION OF MUTUAL INTERFERENCE

1. Please ensure the other indoor unit is OFF.
2. Press **1-6** (PROGRAM NO.) button, **ON** (ON TIMER) button and **Reset** (RESET) button simultaneously. The remote controller will display Screen 1 and followed by Screen 2. The indoor unit beeps to indicate that it has just received the signal from remote controller.

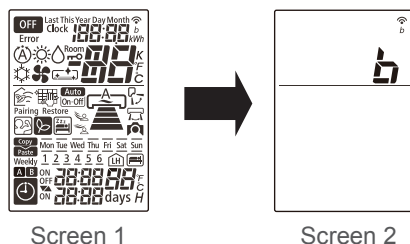

### NOTE:

If indoor unit still not receive the correct signal from the correct remote controller, setting shall be made again. By setting again for the 2nd time, the signal address will change from B to A, then repeat again for the 3rd time.

## 9.5 INTERMITTENT FAN SPEED SETTING

The intermittent fan control during thermo off in Heating Mode can be changed by the remote controller. (This procedure should be done only by service personnel.) It is possible to select from 3 patterns.

### PROCEDURE

1. Press **1** (START/STOP) button, **Mon-Sun** (Mon-Sun) button and press **Reset** (RESET) button simultaneously. Release **Reset** (RESET) button only and make sure that all marks on the remote controller display are indicated, then release **1** (START/STOP) button and **Mon-Sun** (Mon-Sun) button. Remote controller now enters "Intermittent Fan Control Change Mode".

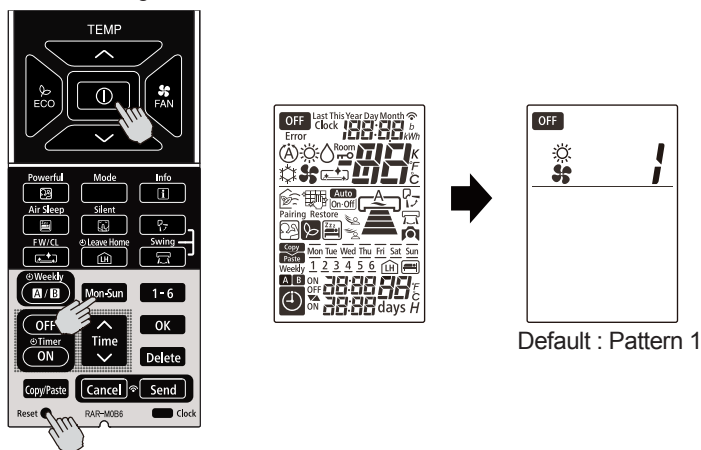

2. Press [ROOM TEMPERATURE setting] [^ (UP)]/[v (DOWN)] buttons. (The intermittent pattern changed with indoor unit beep sound.)

Transmission sign lights up with beep from indoor unit simultaneously.

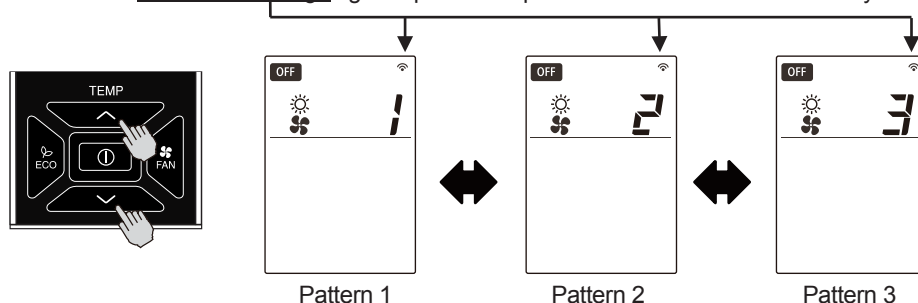



	Pattern 1	Pattern 2	Pattern 3
Single Model	Continuous	30sec ON / 210sec OFF repeatedly	50sec ON / 190sec OFF repeatedly
Multi Model	30sec ON / 210sec OFF repeatedly	50sec ON / 190sec OFF repeatedly	Continuous

## NOTE :

- (1) The indication of the selected intermittent pattern will disappear after 10 seconds.
- (2) The selected intermittent pattern will remain unchanged after the unit is turned off.



## 9.6 FAN SPEED SETTING IN THERMO OFF IN COOLING

The fan speed in Cooling Mode during thermo off can be changed by the remote controller.

(This procedure shall be implemented strictly by service personnel only.)

It is possible to return it to the default setting.

### PROCEDURE

Press  [POWERFUL] button and  [TIME ^ (UP)] button simultaneously for about 5 seconds when the remote controller is OFF.

Transmission sign lights up with beep from indoor unit simultaneously.

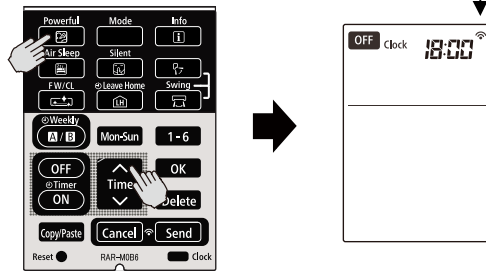

Beep sound pattern :  
 1) Default setting : Short beep  
 2) Changed setting : Double beep



	Fan speed during thermo off
Default Setting	Ultra low
Changed Setting	Set fan speed (When auto fan speed is set, the fan speed is low)

## NOTE :

- (1) The selected fan speed will remain unchanged after the unit is turned off.
- (2) If Timer reservation has been set, it will be canceled.
- (3) During time setting and timer setting, this operation cannot be set.



## 9.7 ERROR CODE INFORMATION

1. In case failure occurs to the air conditioner, by pressing  (INFO) button, an error code will be displayed.
2. Direct the remote controller towards the receiver of indoor unit (within 2 meters in front of indoor unit) and press  (INFO) button.
3. Wait for 2 seconds for signal transmission and the error code will be displayed.

	TIMER LAMP BLINKING	LD1351 BLINKING	CODE	MEANING
INDOOR	-	-	000 00	Normal
	1 time		001 00	Refrigerant cycle fault
	2 times	-	-	Outdoor unit is under forced operation
	3 times	-	003 00	Communication error between indoor and outdoor units
	9 times	-	009 00	Indoor thermistor
	10 times	-	010 00	Abnormal rotating numbers
	12 times	-	012 00	Outdoor interface error
	13 times	-	013 00	IC401 data reading error
OUTDOOR	4 times	2 times	002 01	Peak current cut
	4 times	3 times	003 01	Compressor abnormal low speed rotation
	4 times	4 times	004 01	Compressor switching failure
	4 times	5 times	005 01	Overload lower limit cut
	4 times	6 times	006 01	OH thermistor temperature rise
	4 times	7 times	007 01	Abnormal outdoor thermistor
	4 times	8 times	008 01	Communication error between micon
	4 times	9 times	009 01	Indoor type mis-matched
	4 times	10 times	010 01	Abnormal power source
	4 times	11 times	011 01	Fan stop for strong wind
	4 times	12 times	012 01	Fan motor fault
	4 times	13 times	013 01	EEPROM reading error
	4 times	14 times	014 01	Active converter defective
	4 times	15 times	015 01	Abnormal PWB circuit



	TIMER LAMP BLINKING	LD1351 Lit LD1352 BLINKING	CODE	MEANING
OUTDOOR	4 times	1 times	071 01	Overheat thermostat
	4 times	2 times	072 01	Defrost thermostat
	4 times	3 times	073 01	Outdoor temperature thermostat
	4 times	4 times	074 01	Narrow pipe thermostat (indoor 1)
	4 times	5 times	075 01	Wide pipe thermostat (indoor 1)
	4 times	6 times	076 01	Narrow pipe thermostat (indoor 2)
	4 times	7 times	077 01	Wide pipe thermostat (indoor 2)
	4 times	8 times	078 01	Narrow pipe thermostat (indoor 3)
	4 times	9 times	079 01	Wide pipe thermostat (indoor 3)
	4 times	10 times	080 01	Narrow pipe thermostat (indoor 4)
	4 times	11 times	081 01	Wide pipe thermostat (indoor 4)
	4 times	12 times	082 01	Narrow pipe thermostat (indoor 5)
	4 times	13 times	083 01	Wide pipe thermostat (indoor 5)



## 9.8 ADDITIONAL FUNCTION VIA DIP-SWITCH SETTINGS

A new DIP Switch is available on the PWBs of the indoor unit that provide additional functions via the settings on the switches.

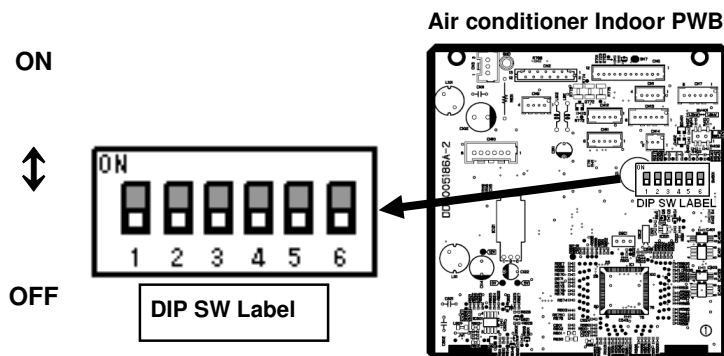

Pin No.	Function	Switch Position / Setting					
		OFF	Enable	ON	Disable		
1	AUTO RESTART function	OFF	Enable	ON	Disable		
2	DRY CONTACT function	OFF	Disable	ON	Enable		
3	DRY CONTACT Logic Select	OFF	HI Input Active	ON	LO Input Active		
4	HEATING / COOLING ONLY MODE SELECT	OFF	NORMAL (HEAT AND COOL)	OFF	HEATING ONLY	ON	COOLING ONLY
5		OFF		ON		OFF	
6	REMOCON ID SELECT ❖1	OFF	SELECT ID A	ON	SELECT ID B		

NOTE:

- ❖1 The setting of pin no. 6 is disabled for this model. Please refer to **9.4 SETTING THE PREVENTION OF MUTUAL INTERFERENCE**.

### 9.8.1 AUTO RESTART FUNCTION

The AUTO RESTART function can be enabled or disabled by setting Pin No. 1 on the DIP SWITCH above to the ON or OFF position accordingly.

### 9.8.2 HEATING/COOLING ONLY MODE SELECTION



When this function is enabled, the operation mode could be locked to either Heating Only (Heating or Fan) or Cooling Only (Cooling, Fan or Dehumidifying) by setting the Pin No. 4 and 5 accordingly.









LOCKED MODE	REMARKS
HEATING ONLY	Unit will not enter into Cooling mode although cooling mode is selected using the remote controller.
COOLING ONLY	Unit will not enter into Heating mode although heating mode is selected using the remote controller.



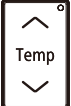





## 9.9 WIRELESS REMOTE CONTROL FUNCTION

### RAR-M0B3、RAR-M0B4、RAR-M0B5

RAR-M0B3	RAR-M0B4	RAR-M0B5
		
RAF-SH07QHAE    RAI-SH07QHAE RAF-SH09QHAE    RAI-SH09QHAE RAF-SH12QHAE    RAI-SH12QHAE RAF-SH18QHAE    RAI-SH18QHAE	RAD-SH07QHAE RAD-SH09QHAE RAD-SH12QHAE RAD-SH18QHAE	RAS-EH07QHAE RAS-EH09RHAE RAS-EH12RHAE RAS-EH18RHAE

BUTTONS	FUNCTION
	<b>MODE selector Button</b> Use this button to select the operating mode. Every time you press this button, the mode will change from (A) (AUTO) → ☀ (HEAT) → 💧 (DEHUMIDIFY) → ❄ (COOL) and (FAN) → 🌀 cyclically.
	<b>ECO Button</b> Use this button to set the ECO mode.
	<b>TEMPERATURE Button</b> Room temperature setting. Value will change quicker when keep pressing.
	<b>ON/OFF Button</b> Press this button to start operation. Press it again to stop operation.
	<b>FAN SPEED Button</b> Select the fan speed for cooling and heating mode.
	<b>TIMER OFF Button</b> Select the turn OFF time.
	<b>TIMER ON Button</b> Select the turn ON time.
	<b>POWERFUL Button</b> Press this button to start powerful operation.











	<b>FROST WASH/CLEAN Button</b> The dust and dirt adhering to indoor heat exchanger which is the cause of the smell. They are washed away by freezing and thawing of the heat exchanger.
	<b>ONE TOUCH CLEAN button</b> Drying indoor heat exchanger after cooling operation to prevent mildew.
	<b>UP/DOWN Button</b> Control the angle of the horizontal air deflector.
	<b>LEAVE HOME Button</b> Prevent the room temperature from falling too much by setting temperature 10°C~16°C when no one is at home.
	<b>SILENT button</b> Use this button to set the SILENT mode.
	<b>ECO SLEEP TIMER button</b> Use this button to set the ECO sleep timer.







For more information, please refer to the operation manual.

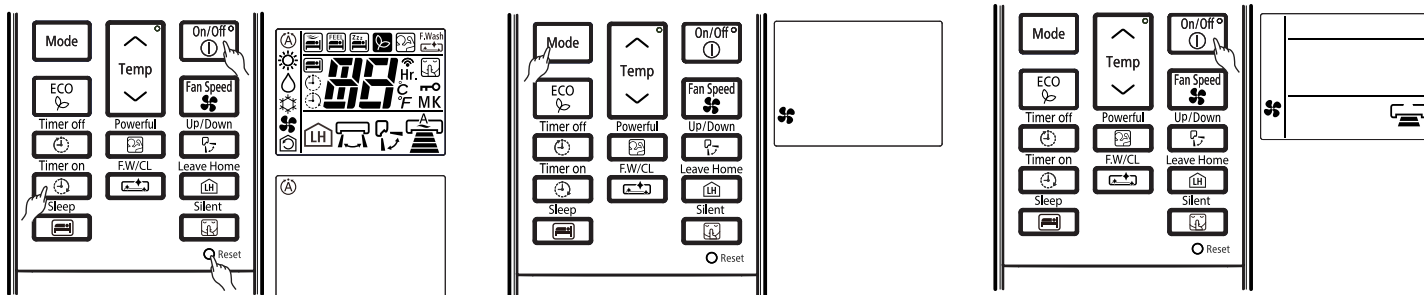

## 9.10. SHIFT VALUE



1. While pressing and holding  (ON/OFF) button and  button, press  [RESET] button on the same.  
Release  [RESET] button only and make sure that all marks on the remote controller display are indicated then release the  (ON/OFF) button and  button. Remote controller now enters "Shift Value Change Mode".
2. Press the  (MODE) selector button so that the display indicates  (FAN) mode.
3. Press the  ( ON/OFF ) button and FAN operation will be started.

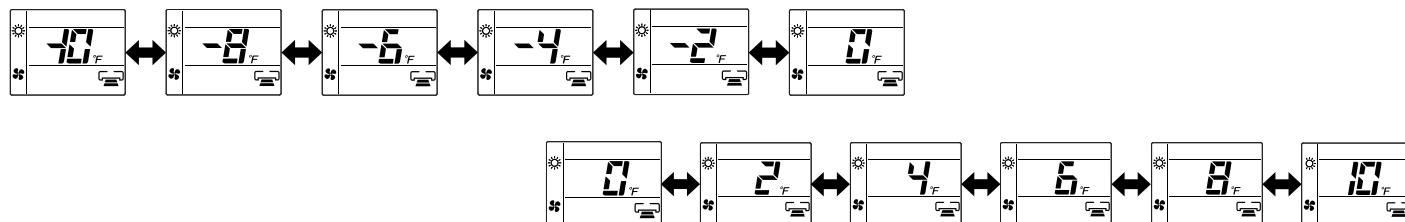
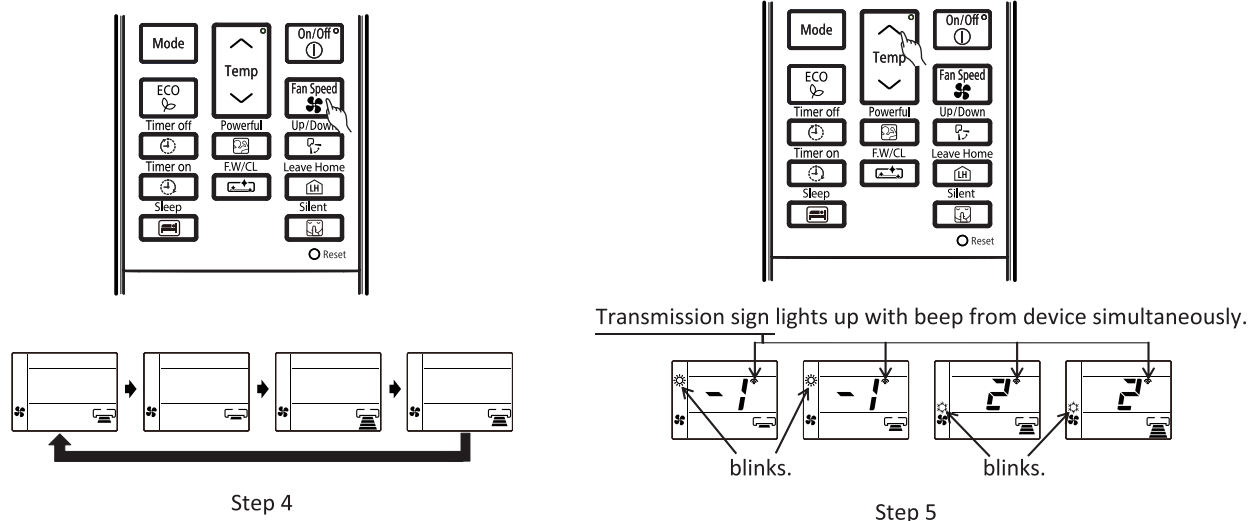

4. Set the FAN SPEED with the  (FAN SPEED) button according to the following FAN speed setting in order to choose the desired operation mode that is required for shift value temperature modification.
  - To change the shift value for COOLING mode operation, select either  (HIGH) or  (MED) FAN SPEED.
  - To change the shift value for HEATING mode operation, select either  (LOW) or  (SILENT) FAN SPEED.
5. Press the (TEMP  or  ) button to change the shift value. (The shift value changed with device producing beep sound.)



### NOTE :









1. The displayed shift value,  (HEAT) and  (CO OL) symbol on the remote controller display will disappear after 10 seconds.
2. The changed shift value will remain unchanged after turned off the power.
3. If "0" is displayed on the remote controller display, it indicates the shift value is now at the initial setting .





## 9.11. DISPLAY OPERATION MODE SETTING

For operating indoor unit independently (without outdoor unit connection), remote controller must be set according to below procedures before send the signal to the indoor unit. New communication format between indoor and outdoor is required to communicate with outdoor unit.

### PROCEDURE

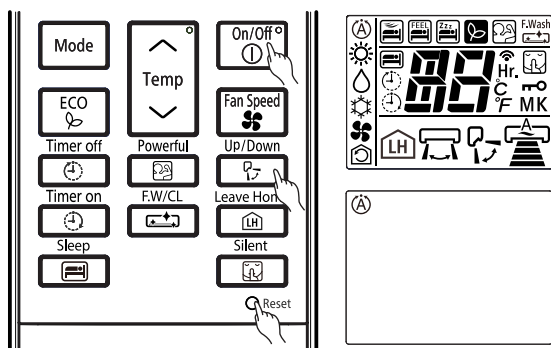
1. While pressing and holding  (ON/OFF) button and  (UP/DOWN) button, press  (RESET) button on the same time. Release  (RESET) button only and make sure that all marks on the LCD display are indicated, then release the  (ON/OFF) button and  (UP/DOWN) button. Remote controller now enters "DISPLAY OPERATION MODE" for the indoor unit to run independently. Please ensure that when pressing  (FAN SPEED) button, "  " will be blinking.



2. Press the  (MODE) selector button to choose the desired operation mode.
3. Press  (ON/OFF) button.

Then , the indoor unit will starts to operate independently according the selected operation mode.

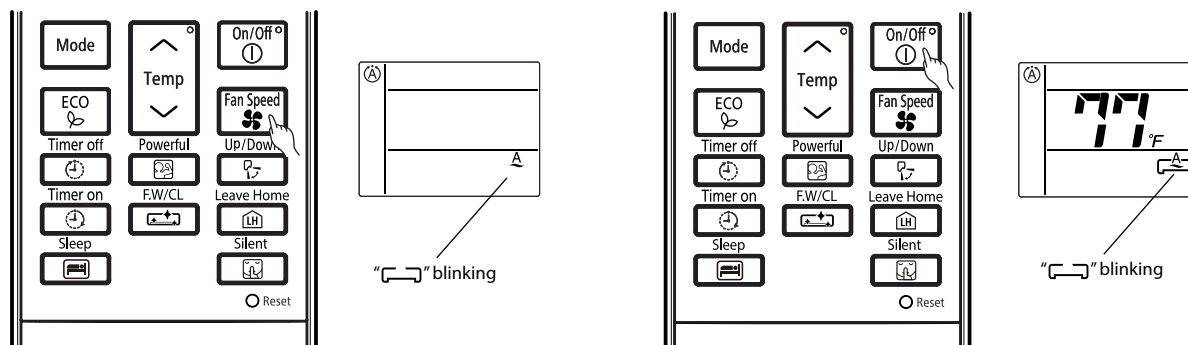

### NOTE :







- (1) During "DISPLAY OPERATION MODE", "  " blinks on LCD of remote controller.
- (2) When operation stops, "DISPLAY OPERATION MODE" is canceled.



### 9.12. HOW TO CHANGE THE INTERMITTENT FAN CONTROL SETTING

The intermittent fan control during thermo off in Heating mode can be changed by the remote controller.  
 (The procedure should be done only by service personnel.)  
 It is possible to select from 3 patterns.

**PROCEDURE**

Press  (POWERFUL) button,  (FAN SPEED) button and press  [RESET] button simultaneously.  
 Release  [RESET] button only and make sure that all marks on the remote controller display are indicated, then release  (POWERFUL) button and  (FAN SPEED) button.  
 Remote controller now enters "Intermittent Fan Control Change Mode".

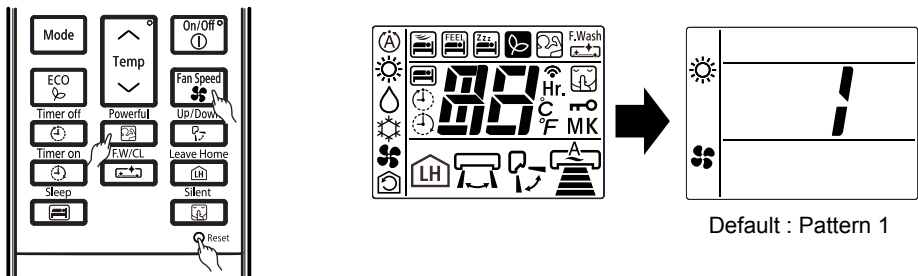

Press [ROOM TEMPERATURE setting] [ ^ (UP) / v (DOWN)] button.  
 (The intermittent pattern changed with indoor unit beep sound)

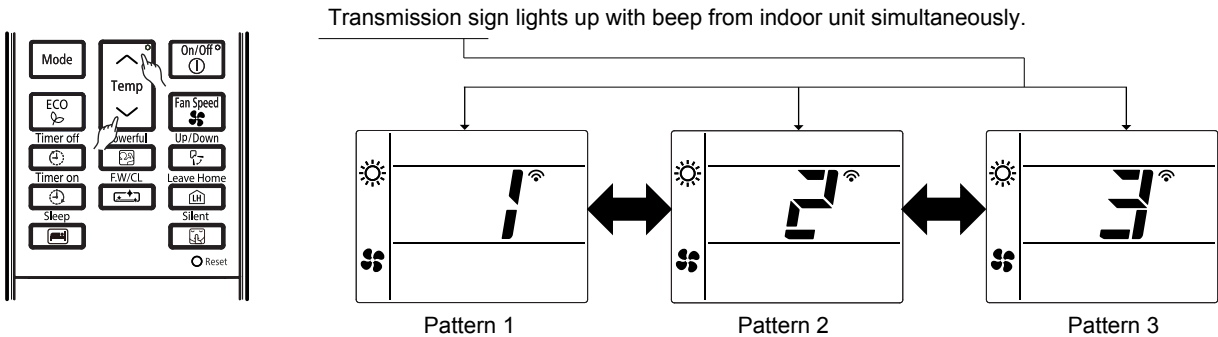

	Pattern 1	Pattern 2	Pattern 3
Single model	Continuous	30sec ON / 210sec OFF repeatedly	50sec ON / 190sec OFF repeatedly
Multi	30sec ON / 210sec OFF repeatedly	50sec ON / 190sec OFF repeatedly	Continuous



- NOTE :
- (1) The indication of the selected intermittent pattern will disappear after 10 seconds.
  - (2) The selected intermittent pattern will remain unchanged after the unit is truned off.



9.13. HOW TO CHANGE THE FAN SPEED IN COOLING MODE DURING THERMO OFF

The fan speed in Cooling Mode during thermo off can be changed by the remote controller.  
(This procedure shall be implemented strictly by service personnel only.)  
It is possible to return it to the default setting.

PROCEDURE

Press  [POWERFUL] button and  [ECO] button simultaneously for about 5 seconds when the remote controller is OFF.

Transmission sign lights up with beep from indoor unit simultaneously.

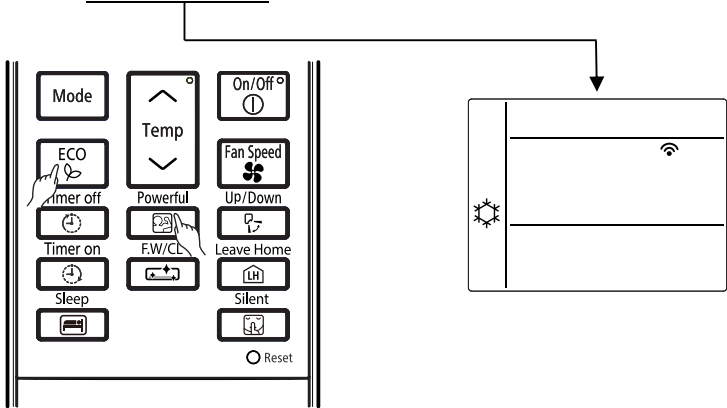

- Beep sound pattern :
- 1) Default setting : Short beep
  - 2) Changed setting : Double beep

	Fan speed during thermo off
Default Setting	Ultra low
Changed Setting	Set fan speed (When auto fan speed is set, the fan speed is low)

- NOTE :
- (1) The selected fan speed will remain unchanged after the unit is turned off.
  - (2) If Timer reservation has been set, it will be canceled.
  - (3) During time setting and timer setting, this operation cannot be set.



## 9.14. SETTING THE PREVENTION OF MUTUAL INTERFERENCE

a.) Other indoor circuit breakers should be disconnected.



- b.) Remove the back cover of the remote control.
- c.) Cut the jumper as shown below.
- d.) Press "Reset" button after installing the battery.
- e.) Corresponding to the room electrical box dial code 6 to dial on.



Cut (Attention: Remove the battery before cutting. Do not cut with electricity).



f.) Please use the remote control to check the available models of corresponding indoor machines.



## 10 OPTION LIST



### CONTENTS











<b>10</b>	<b>OPTION LIST</b>	<b>10-1</b>
10.1.	WIRED REMOTE CONTROL SPX-RCDA1 AND SPX-RCDB1	10-2
10.1.1.	SHIFT VALUE	10-3
10.1.2.	ERROR CODE INFORMATION	10-4
10.2.	WIRED REMOTE CONTROL SPX-WKT4	10-7
10.2.1.	SERVICE MENU OPERATION	10-8
10.2.1.1.	SERVICE MENU	10-8
10.2.1.2.	DISPLAY ROOM TEMPERATURE	10-9
10.2.1.3.	CONTACT INFORMATION REGISTRATION	10-9
10.2.1.4.	LIMIT OPERATION	10-10
10.2.1.5.	SHIFT CHANGE	10-11
10.2.1.6.	INTERMITTENT FAN CONTROL	10-12
10.2.1.7.	FAN SPEED DURING THERMO OFF	10-13
10.2.1.8.	OPERATION LOCK	10-14
10.2.1.9.	DISPLAY MALFUNCTION	10-15
10.2.1.10.	DISPLAY ALARM HISTORY	10-16
10.2.1.11.	DEFROSTING INHIBIT PERIOD SELECTION	10-17
10.2.1.12.	ECO AUTO OFF	10-18
10.2.1.13.	CLEAN (SERVICE)	10-19
10.2.1.14.	KEY LOCK	10-19
10.2.2.	CHECK MENU OPERATION	10-20
10.2.2.1.	SELF CHECKING	10-20
10.3.	H-LINK ADAPTOR – PSC 6RAD	10-23
10.3.1.	SAFETY SUMMARY	10-23
10.3.2.	INSTALLATION WORK	10-23
10.3.3.	ELECTRICAL WIRING	10-24
10.3.4.	DIP SWITCH SETTING	10-25
10.3.5.	TEST RUN	10-26
10.4.	DRY CONTACT (SPX-WDC2 AND SPX-WDC3) APPLICATION (USING DIP SWITCH)	10-27
10.5.	DISTRIBUTOR – SPX-DST1	10-30
10.6.	REMOTE SENSOR - SPX-RTH1	10-31
10.6.1.	SELECTION OF INSTALLATION POSITION	10-31
10.6.2.	INSTALLATION PROCEDURE	10-31
10.6.3.	WIRING PROCEDURES	10-31



## 10.1 WIRED REMOTE CONTROL SPX-RCDA1 AND SPX-RCDB1



This controls the operation function and timer setting of the room air conditioner.

SPX-RCDA1	SPX-RCDB1
	
RAD-SH07QHLAE RAD-SH09QHLAE RAD-SH12QHLAE RAD-SH18QHLAE	<div>             RAS-EH07QHLAE    RAF-SH07QHLAE              RAS-EH09RHLAE    RAF-SH09QHLAE              RAS-EH12RHLAE    RAF-SH12QHLAE              RAS-EH18RHLAE    RAF-SH18QHLAE           </div> <div>             RAS-SH07QHLAE    RAI-SH07QHLAE              RAS-SH09RHLAE    RAI-SH09QHLAE              RAS-SH12RHLAE    RAI-SH12QHLAE              RAS-SH18RHLAE    RAI-SH18QHLAE           </div>

BUTTONS	FUNCTION
	<b>MODE Selector</b> Use this button to select the operation mode. Every time you press this button, the mode will change from (AUTO) → (HEAT) → (DEHUMIDIFY) → (COOL) cyclically.
	<b>FAN SPEED Selector Button</b> This determines the fan speed. Every time you press this button, the airflow rate will change from (AUTO) → (HIGH) → (MED) → (LOW) → (SILENT) (This button allows selection of optimal or preferred fan speed for each operation mode).
	<b>ON/OFF button</b> Press this button to start operation. Press it again to stop operation.
	<b>SLEEP button</b> Use this button to set the SLEEP timer.
	<b>SET button</b> Timer setting reservation.
	<b>OFF button</b> Select the turn OFF timer.
	<b>ON button</b> Select the turn ON timer.
	<b>CANCEL button</b> Cancel timer reservation.
	<b>AUTO SWING (Vertical) button</b> Controls the angle of the horizontal air deflector.
	<b>ROOM TEMPERATURE setting button</b>



### 10.1.1 SHIFT VALUE

1. Press and hold ① (ON/OFF) button and  (ON TIMER) button at the same time while giving a single press on the RESET button until remote controller now enter 'Shift value change mode'.
2. Press ① (ON/OFF) button so that the display indicates  (FAN) speed.
3. Select  (FAN SPEED) button to choose Heating Shift or Cooling Shift Mode.

By setting fan speed to HIGH  or MED  , it will go to Cooling Shift mode.

By setting fan speed to LOW  or SILENT  , it will go to Heating Shift mode.

4. Press  (ROOM TEMPERATURE) button to change the shift value (-5°C ~ 0 ~ 5°C).
5. Press ① (ON/OFF) button to end 'Shift value setting mode'.











#### NOTE:

1. There are total of 11 shift values ranging from -5 to 5.
2. The changed shift value will remain unchanged after turned off the power.

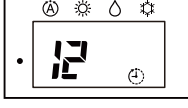









## 10.1.2 ERROR CODE INFORMATION



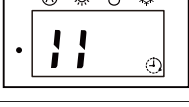
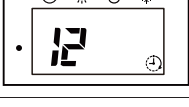
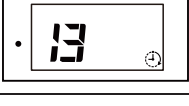
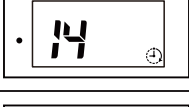







1. In case failure occurs to the air conditioner, the error code will constantly appear on the wired remote controller display.

	TIMER LAMP BLINKING	LD1351 BLINKING	CODE	MEANING
INDOOR	-	-	-	Normal
	1 time	-		Refrigerant cycle fault
	2 times	-	-	Outdoor unit is under forced operation
	3 times	-		Communication error between indoor and outdoor units
	9 times	-		Indoor thermistor
	10 times	-		Abnormal rotating numbers
	12 times	-		Outdoor interface error
	13 times	-		IC401 data reading error
OUTDOOR	4 times	2 times		Peak current cut
	4 times	3 times		Compressor abnormal low speed rotation
	4 times	4 times		Compressor switching failure
	4 times	5 times		Overload lower limit cut



	TIMER LAMP BLINKING	LD1351 BLINKING	CODE	MEANING
OUTDOOR	4 times	6 times		OH thermistor temperature rise
	4 times	7 times		Abnormal outdoor thermistor
	4 times	8 times		Communication error between micon
	4 times	9 times		Indoor type mis-matched
	4 times	10 times		Abnormal power source
	4 times	11 times		Fan stop for strong wind
	4 times	12 times		Fan motor fault
	4 times	13 times		EEPROM reading error
	4 times	14 times		Active converter defective
	4 times	15 times		Abnormal PWB circuit
		LD1351 Lit LD1352 BLINKING		
	4 times	1 times		Overheat thermostat
	4 times	2 times		Defrost thermostat



	TIMER LAMP BLINKING	LD1351 Lit LD1352 BLINKING	CODE	MEANING
OUTDOOR	4 times	3 times		Outdoor temperature thermostat
	4 times	4 times		Narrow pipe thermostat (indoor 1)
	4 times	5 times		Wide pipe thermostat (indoor 1)
	4 times	6 times		Narrow pipe thermostat (indoor 2)
	4 times	7 times		Wide pipe thermostat (indoor 2)
	4 times	8 times		Narrow pipe thermostat (indoor 3)
	4 times	9 times		Wide pipe thermostat (indoor 3)
	4 times	10 times		Narrow pipe thermostat (indoor 4)
	4 times	11 times		Wide pipe thermostat (indoor 4)
	4 times	12 times		Narrow pipe thermostat (indoor 5)
	4 times	13 times		Wide pipe thermostat (indoor 5)



## 10.2 WIRED REMOTE CONTROL SPX-WKT4

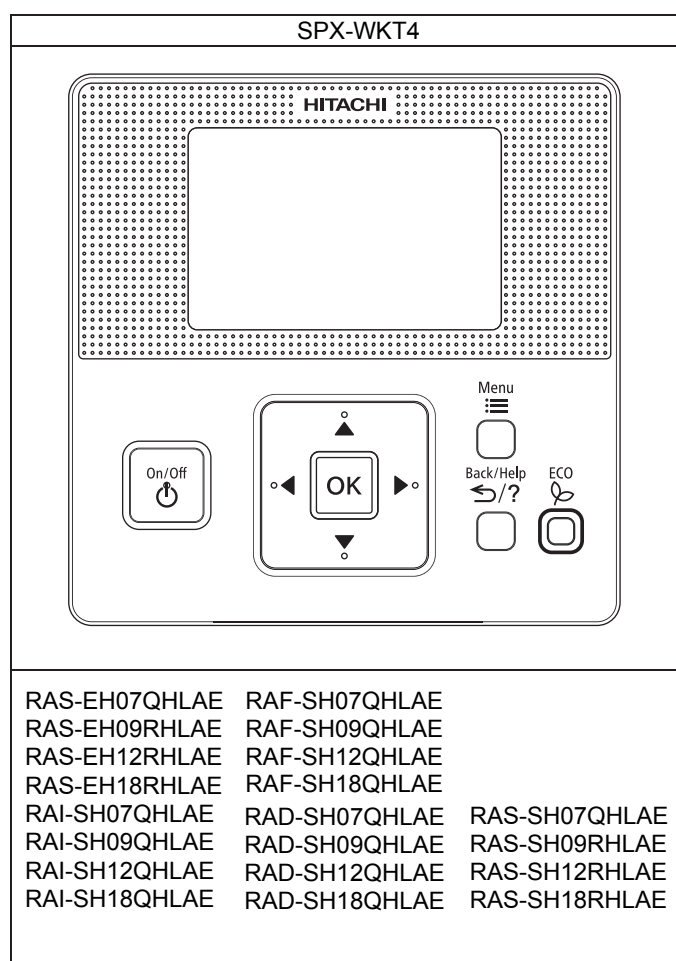



## 10.2.1 SERVICE MENU OPERATION



### 10.2.1.1 SERVICE MENU

Various setting functions are displayed in the service menu. This procedure shall be implemented strictly by service personnel only. After implementing this procedure, test run must be performed to ensure that the procedure has been done as intended, without any issues. Refer to the following sections for each function.

#### NOTE:

☒ : Unable to set

- If the function with "☒" is selected from the menu, "Setting Disabled" will be displayed on the lower screen.
- The image in case of Celsius setting of setting temperature is shown in this manual as the example.

- 1 Press and hold  and  simultaneously for at least 3 seconds during the normal mode. The service menu will be displayed.

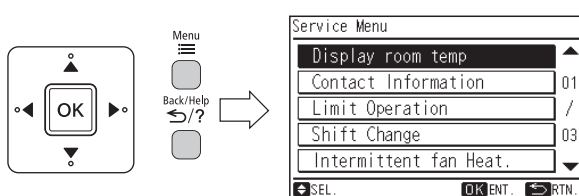

- 3 Press "/?" (return/help) to return to the normal mode.

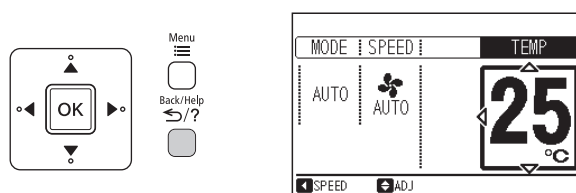

- 2 Select the "Service Menu" function by pressing "△" or "▽" and press "OK". ("☒" will be displayed if the function is not available.)

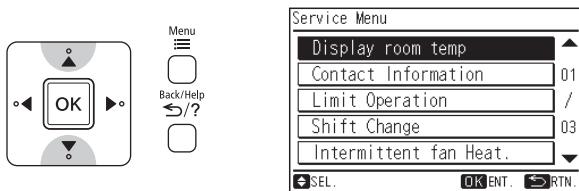

Page 1/3

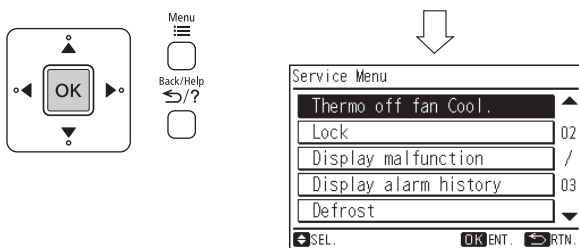

Page 2/3

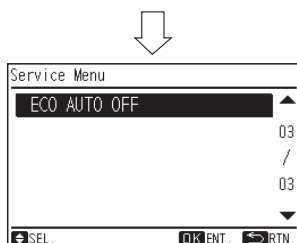

Page 3/3

#### NOTE:

- If the menu screen remains unchanged for approximately 2 hours, the screen will automatically return to the normal mode.

#### NOTE:

- The "Service Menu" functions vary depending on which is displayed in the stop and in operation, or model-wise.



### 10.2.1.2 DISPLAY ROOM TEMPERATURE

Room temperature(around remote controller) can be displayed.

- 1 Select "Display room temp" from the service menu and press "OK".  
The confirmation screen will be displayed.

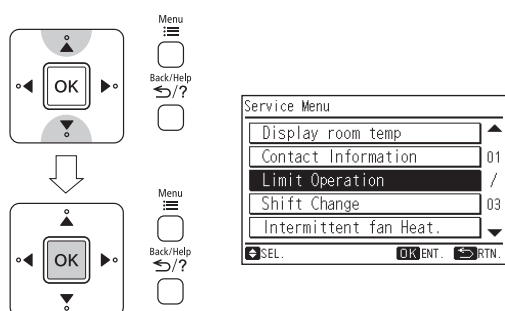

- 2 Select "Yes" by pressing "<" or ">" and press "OK". The setting will be confirmed and the screen will return to the normal mode.

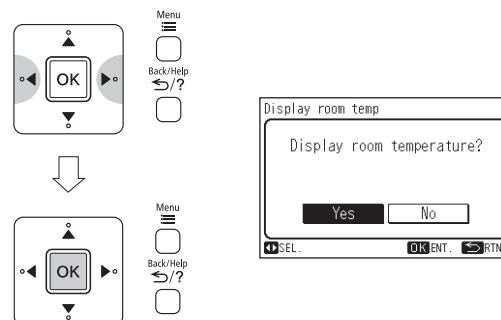

### 10.2.1.3 CONTACT INFORMATION REGISTRATION

Contact information can be registered from "Contact information".

- 1 Select "Contact information" from the service menu and press "OK". The contact information 1 will be displayed.

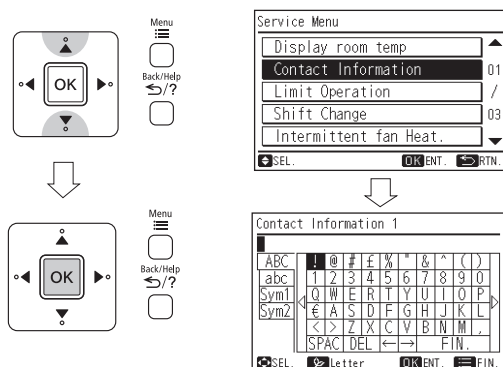

- 5 Select "FIN." and press "OK" (or simply press Menu). "Contact information 2" will be displayed.

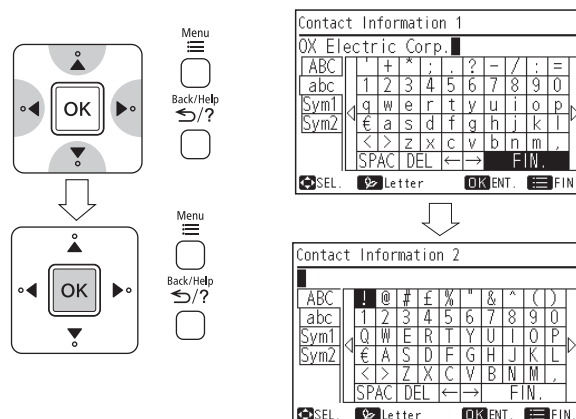

- 2 Press  to change font type.
- 3 Press "< >" to select letter.
- 4 Press "OK" to confirm the letter. (Max.: 28 letters)

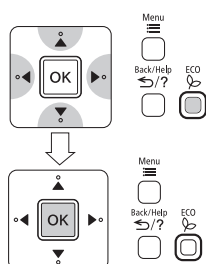

- 6 Repeat (3)-(5) to register the contact information 2.

Select "FIN." and press "OK", the confirmation screen will be displayed.  
(Also press  and the confirmation screen will be displayed. )

- 7 Select "Yes" and press "OK". The service menu will be displayed after setting is confirmed. If "No" is pressed, the screen will return to (3).

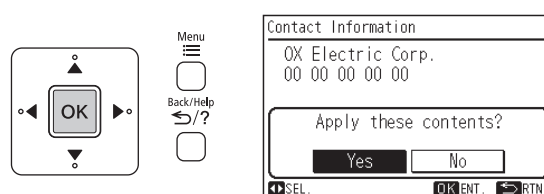
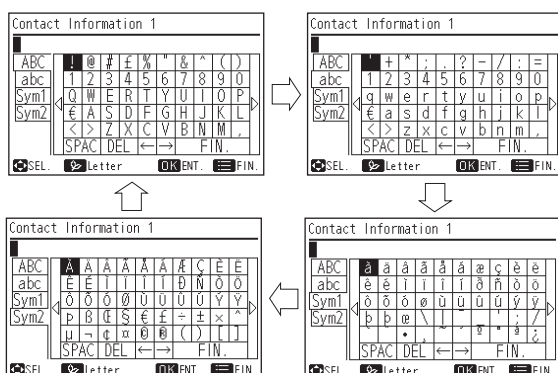



### 10.2.1.4 LIMIT OPERATION

Setting temperature range can be changed.

- 1 Select "Limit Operation" from the service menu and press "OK".  
The limit operation setting will be displayed.

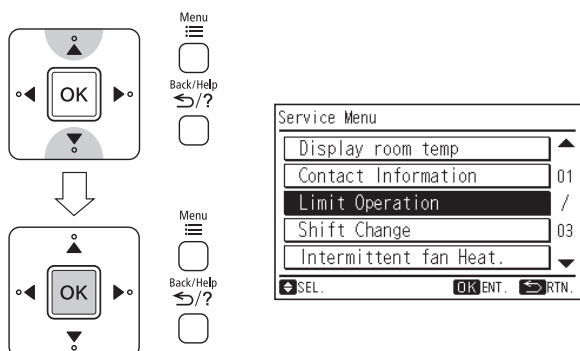

- 2 Press " $\Delta$ " or " $\nabla$ " to select the setting items. The setting items are displayed "Limit Setting", "Cool-Dry", "Heat" and "Auto".

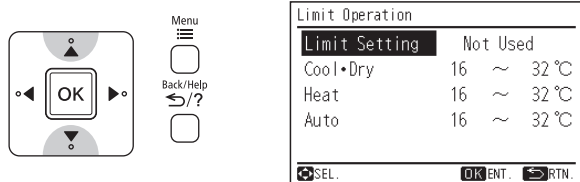

- 3 Press " $\triangleleft$ " or " $\triangleright$ " to set each setting content for the selected item. When "Limit Setting" is selected, the setting contents are switched in order of "Not Used"  $\leftrightarrow$  "Used" by pressing " $\Delta$ " or " $\nabla$ ". When "Cool-Dry" or "Heat" or "Auto" is selected, the setting temperature (lower limit or upper limit) can be set every 1°C (1°F) by pressing " $\Delta$ " or " $\nabla$ ".

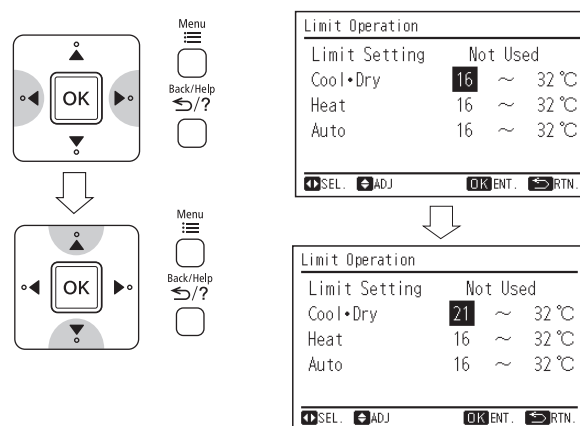

- 4 Press "OK" to finish the limit operation setting. The confirmation screen will be displayed.

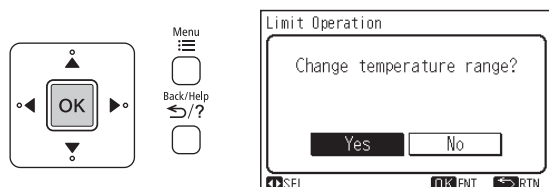

- 5 Select "Yes" by pressing " $\triangleleft$ " or " $\triangleright$ " and press "OK".

The setting will be confirmed and the screen will return to the service menu.

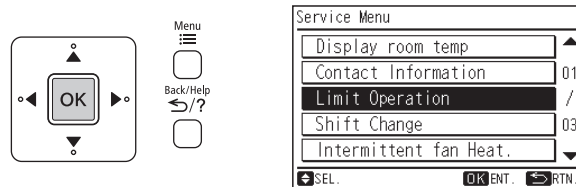

- 6 Press "Back/Help" (return/help) to return to the normal mode.

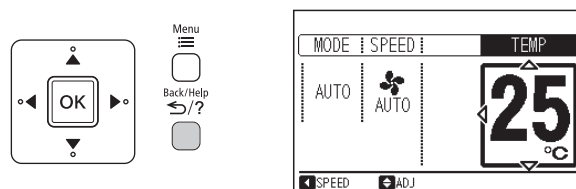

#### NOTE:

- The limit operation setting will remain unchanged after the unit is turned off.



### 10.2.1.5 SHIFT CHANGE

The shift value setting temperature for cooling and heating mode operation can be changed.

- 1 Select "Shift Change" from the service menu and press "OK". The shift change setting will be displayed.

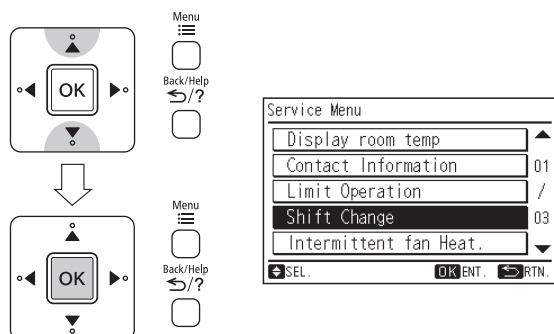

- 2 Press "△" or "▽" to select the operation mode. ("COOL" or "HEAT")

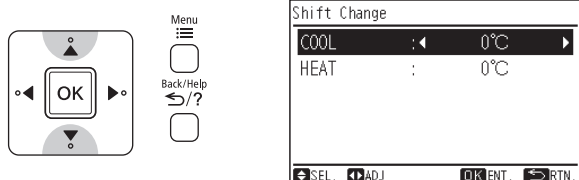

- 3 By pressing "◀" or "▶", the shift value will be changed as below.

"...+5°C ↔ -5°C ↔ -4°C ↔ -3°C ↔ -2°C  
 ↔ -1°C ↔ 0°C ↔ +1°C ↔ +2°C ↔  
 +3°C ↔ +4°C ↔ +5°C ↔ -5°C (+10°F  
 ↔ -10°F ↔ -8°F ↔ -6°F ↔ -4°F ↔  
 -2°F ↔ 0°F ↔ +2°F ↔ +4°F ↔ +6°F  
 ↔ +8°F ↔ +10°F ↔ -10°F...)"

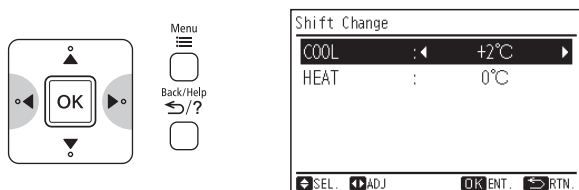

- 4 Press "OK" to finish the shift value setting. The confirmation screen will be displayed.

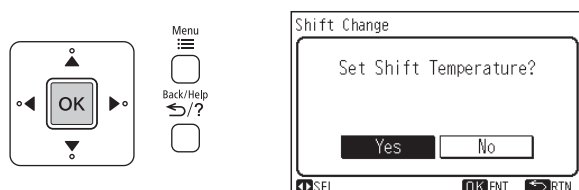

- 5 Select "Yes" by pressing "◀" or "▶" and press "OK".

The setting will be confirmed and the screen will return to the service menu.

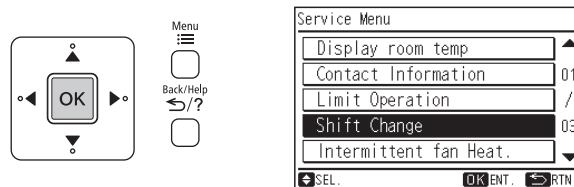

- 6 Press "Back/Help" (return/help) to return to the normal mode.

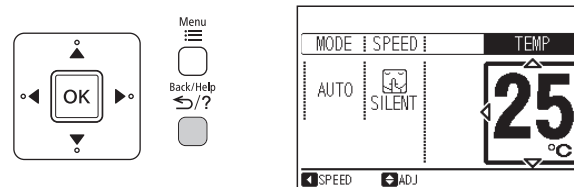

#### NOTE:

- When the setting is done, fan speed basically will be changed to "Silent"
- This setting cannot use during operation.
- The shift change setting will remain unchanged after the unit is turned off.
- Some indoor units are available from -3°C (-6°F) to +3°C (+6°F) only of shift change. In case of that, shift change setting of -5°C (-10°F), -4°C (-8°F), +4°C (+8°F) or +5°C (+10°F) will not be reflected to indoor unit.



### 10.2.1.6 INTERMITTENT FAN CONTROL

The intermittent fan control during thermo off in Heating mode mode can be changed.

- 1 Select "Intermittent fan Heat." from the service menu and press "OK".  
The intermittent fan control setting will be displayed.

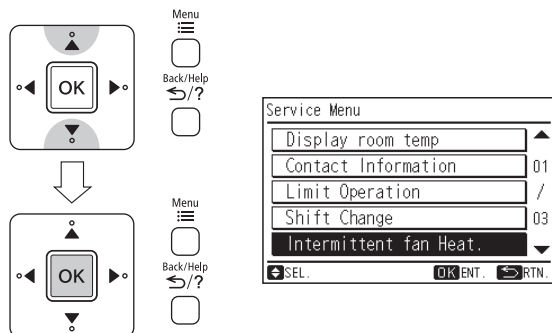

- 2 By pressing "<" or ">", the "Control Type" will be changed as below.  
".... No.1 ↔ No.2 ↔ No.3 ↔ No.1 ..."

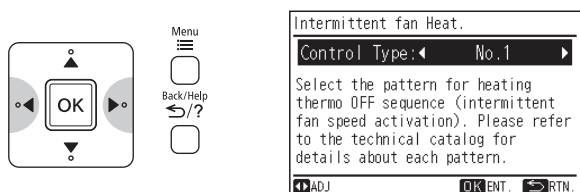

- 4 Select "Yes" by pressing "<" or ">" and press "OK".  
The setting will be confirmed and the screen will return to the service menu.

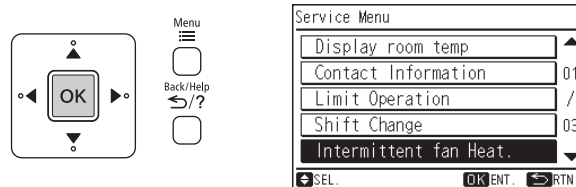

- 5 Press "Back/Help" (return/help) to return to the normal mode.

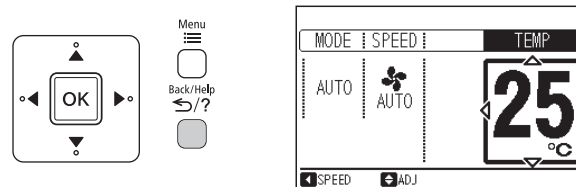

#### NOTE:

- This setting cannot use during operation.
- The intermittent fan control setting will remain unchanged after the unit is turned off.

	Single model	Multi model
No. 1	Continuous	30 sec ON/210 sec OFF repeatedly
No. 2	30 sec ON/210 sec OFF repeatedly	50 sec ON/190 sec OFF repeatedly
No. 3	50 sec ON/190 sec OFF repeatedly	Continuous

- 3 Press "OK" to finish the intermittent fan control setting. The confirmation screen will be displayed.

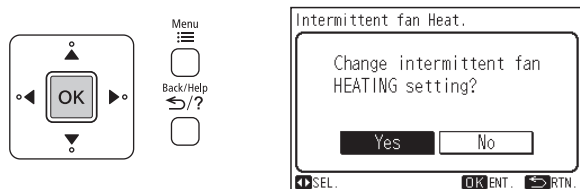



### 10.2.1.7 FAN SPEED DURING THERMO OFF

The fan speed during thermo off in Cooling mode can be changed.

- 1 Select "Thermo off fan Cool." from the service menu and press "OK".

The fan speed during thermo off setting will be displayed.

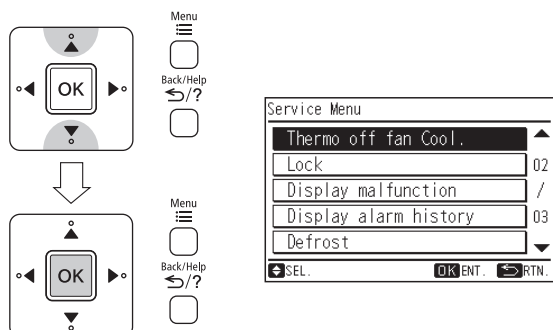

- 2 By pressing "<" or ">", the "Control Type" will be changed as below.

"Default" ↔ "Changed"

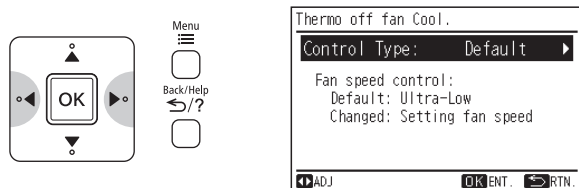

- 4 Select "Yes" by pressing "<" or ">" and press "OK".

The setting will be confirmed and the screen will return to the service menu.

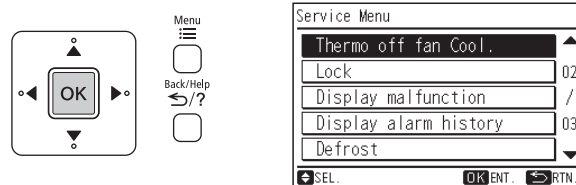

- 5 Press "Back/Help" (return/help) to return to the normal mode.

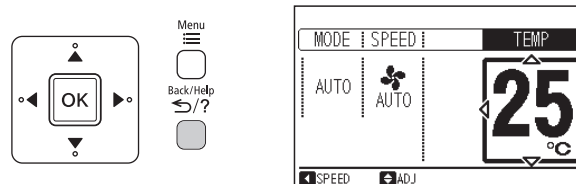

#### NOTE:

- This setting cannot use during operation.
- The fan speed during thermo off setting will remain unchanged after the unit is turned off.

	Fan speed during thermo off
Default	Ultra low
Changed	Set fan speed (When auto fan is set, the fan speed is low.)

- 3 Press "OK" to finish the thermo off fan control setting. The confirmation screen will be displayed.

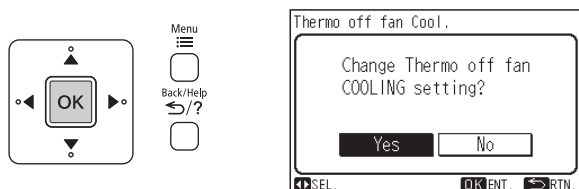



### 10.2.1.8 OPERATION LOCK

This function is used to lock the operation mode from the remote controller.

The remote controller can be set to fix the "Heating" mode (including "Fan"), "Cooling" mode and "Dehumidifying" mode (including "Fan") operations.

- 1 When unit is OFF, select "Lock" from the service menu and press "OK".

The screen of "Mode Lock" selection will be displayed.

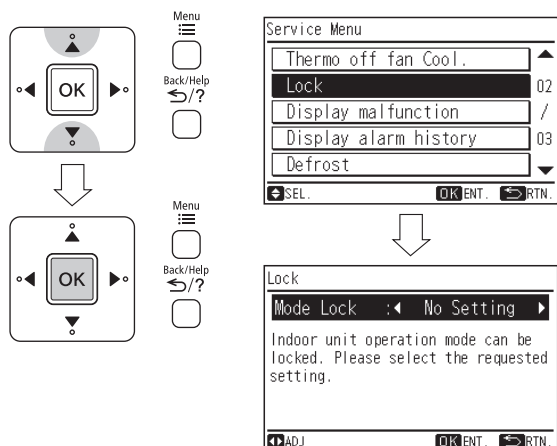

- 2 By repeatedly pressing "<" or ">", the indication is changed in order of "No Setting" ↔ "COOL" ↔ "HEAT"

Select the function target and press "OK".  
The confirmation screen will be displayed.

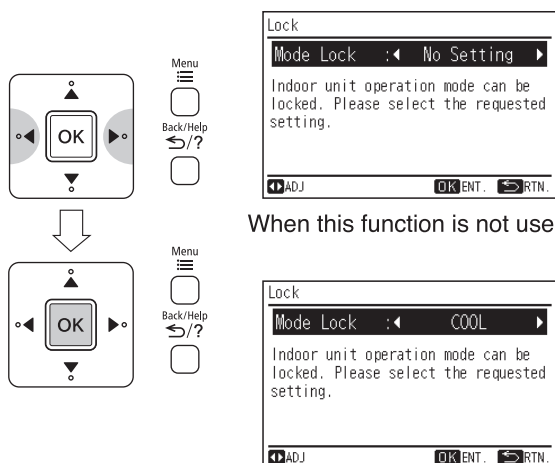

When this function is not used

When "Cooling" mode lock is selected

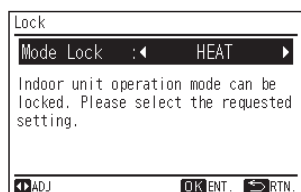

When "Heating" mode lock is selected

- 3 Select "Yes" by pressing "<" or ">" and press "OK".

The setting will be confirmed and the screen will return to the service menu.

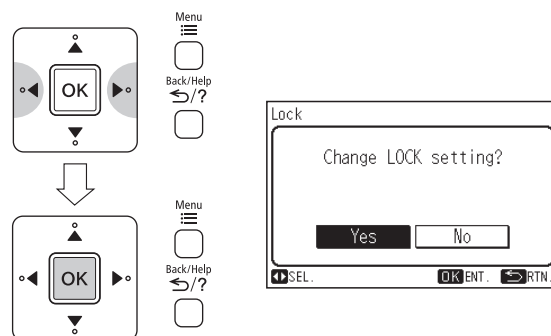

- 4 Press "Back/Help" (return/help) to return to the normal mode.

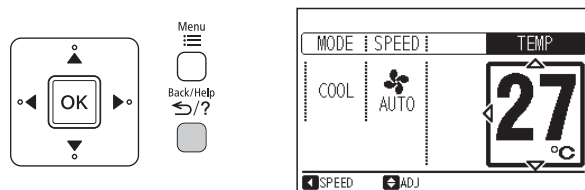

ex. Select "Cooling" mode lock

#### NOTE:

- The operation lock setting will remain unchanged after the unit is turned off.



### 10.2.1.9 DISPLAY MALFUNCTION

Failure modes are stored in the nonvolatile memory of indoor unit and shall be redisplayed by this remote controller. This function is useful in checking the failure modes either during switching OFF the power or restarting the device without checking the error code on display or number of indication lamp blinking. The remote controller can redisplay up to last 5 failure modes from the memory. Thus, for some failure modes which are unable to retrieve because of remote controller limit to redisplay only 5 failure modes, it can be found by cleaning up the memory first then recheck the memory content again during the visit at the customer place.

#### a) How to redisplay failure diagnosis

- 1 Turn the circuit breaker OFF.
- 2 Then turn the circuit breaker ON.
- 3 To enter the service menu.
- 4 Select "Display malfunction" from the service menu and press "OK".

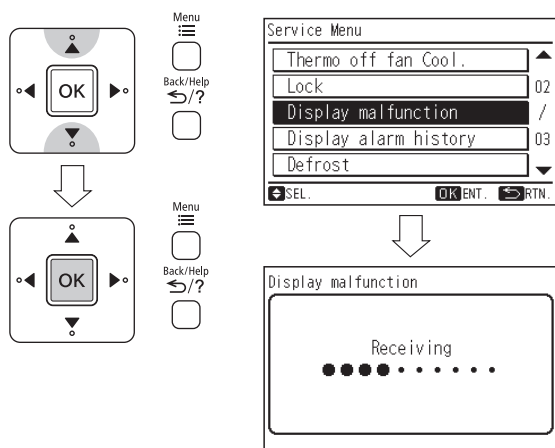

- 5 The last 5 failure modes from the memory will be displayed.

Display malfunction	
Unit	Code
Last IN	010
IN	010
IN	010
IN	009
IN	009

#### NOTE:

- During display, the timer lamp of indoor unit will blink at the last failure mode.

- 6 Press "Back/Help" (return/help) to return to the normal mode.

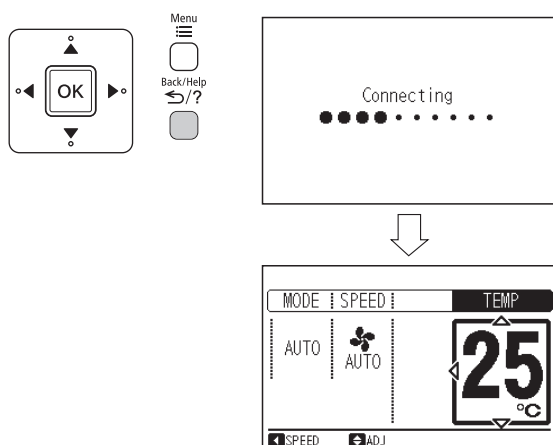

#### b) How to clear the failure diagnosis data

- 1 Redisplay the failure diagnosis data.
- 2 To enter the service menu.

- 3 Select "Display malfunction" from the service menu and press "OK".

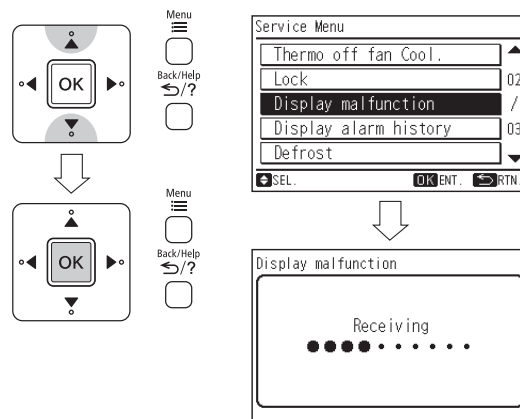

- 4 The last 5 failure modes from the memory will be displayed. "OK DeIAII" is displayed in this time.

Display malfunction	
Unit	Code
Last IN	010
IN	010
IN	010
IN	009
IN	009

- 5 Press "OK". The confirmation screen is displayed. Select "Yes" by pressing "<" or ">" and press "OK".  
When the failure diagnosis data is cleared, the screen will automatically return to the normal mode.

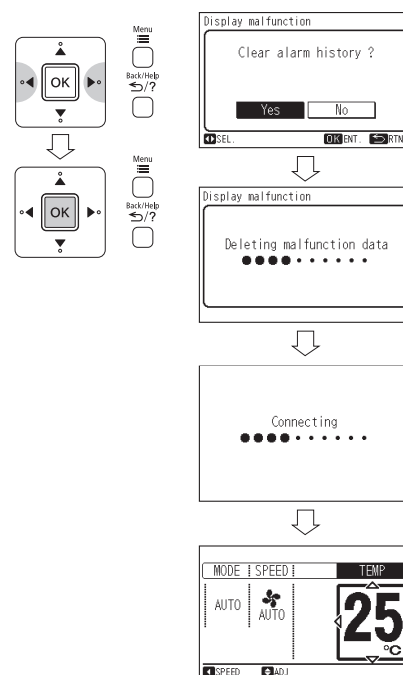

#### NOTE:

- The clear mode is valid only once after section "1.9.1".



### 10.2.1.10 DISPLAY ALARM HISTORY

The history of failure modes are also stored in the nonvolatile memory of this remote controller. This function is useful for when a failure to check whether or not occurred. (Time and date is also indicated.)

The remote controller can memorize to last 10 failure modes in the memory.

#### a) How to display alarm history

- 1 To enter the service menu.
- 2 Select "Display alarm history" from the service menu and press "OK".

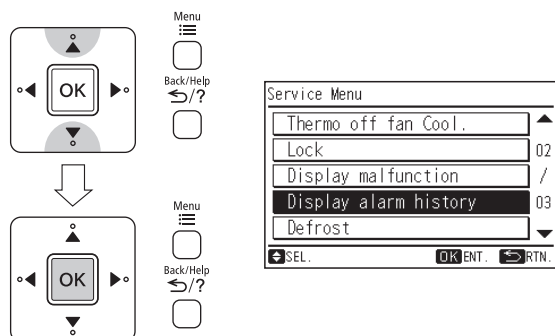

- 3 The last 10 failure modes (up to 5 failure modes per one screen) in the memory will be displayed. By pressing "△" or "▽", scroll page.

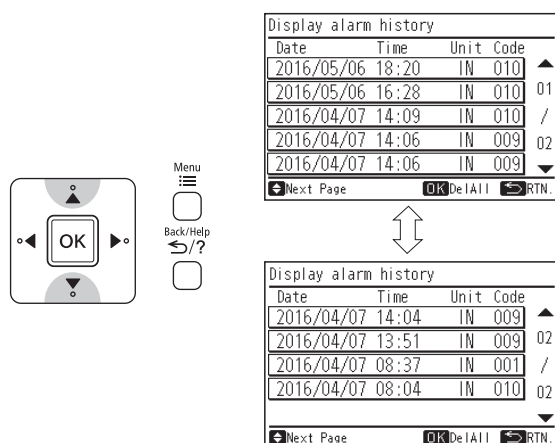

- 4 Press " Back/Help " (return/help) twice to return to the normal mode.

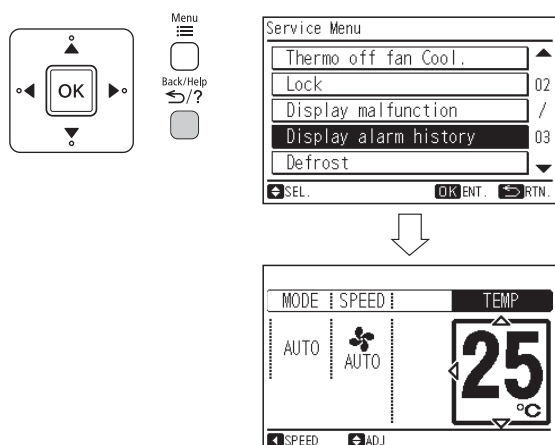

#### b) How to clear the alarm history

- 1 Redisplay the alarm history. (Refer to section "1.10.1")
- 2 Press "OK". The confirmation screen is displayed. Select "Yes" by pressing "◀" or "▶" and press "OK".

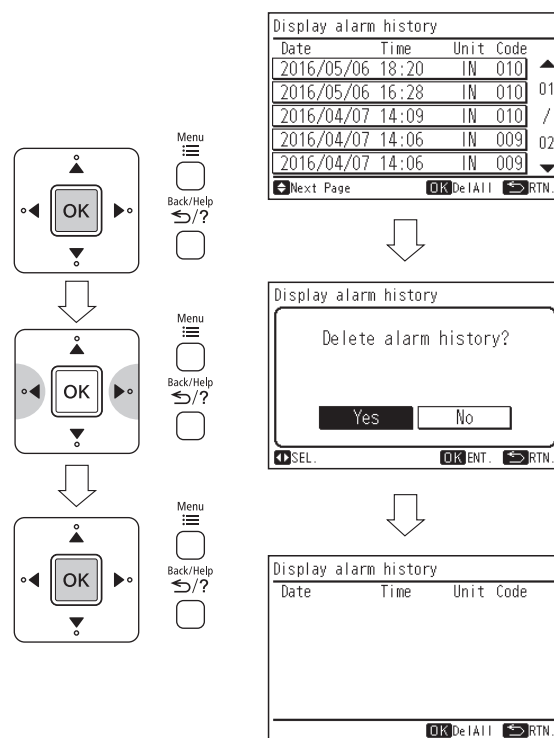

- 3 Press " Back/Help " (return/help) twice to return to the normal

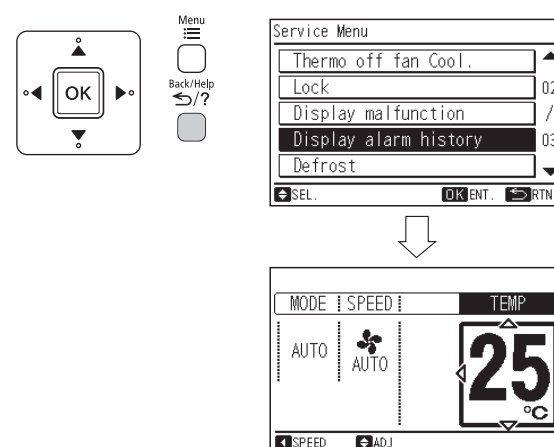



### 10.2.1.11 DEFROSTING INHIBIT PERIOD SELECTION

The defrosting inhibit period selection can be changed.  
This selection is valid with the single model only.

- 1 Turn the circuit breaker OFF.
- 2 Then turn the circuit breaker ON.
- 3 To enter the service menu.
- 4 Select "Defrost" from the service menu and press "OK".

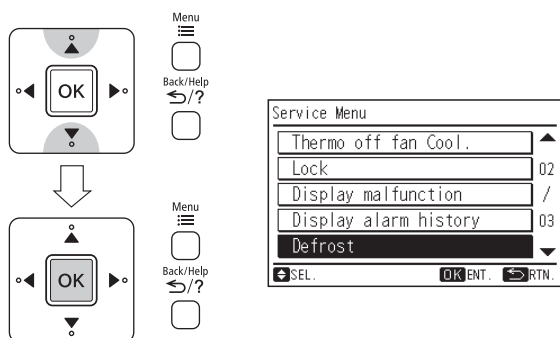

- 5 By pressing "<" or ">", the "Control Type" will be changed as below.

"Default" ↔ "Changed"

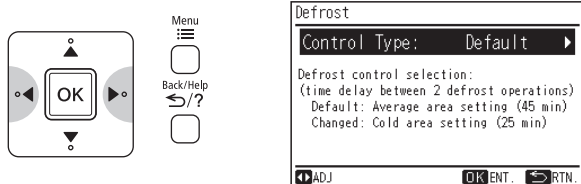

	Defrosting inhibit period
Default	Average area setting (Around 45 min)
Changed	Cold area setting (Around 25 min)

- 6 Press "OK" to finish the defrosting inhibit period selection setting. The confirmation screen will be displayed.

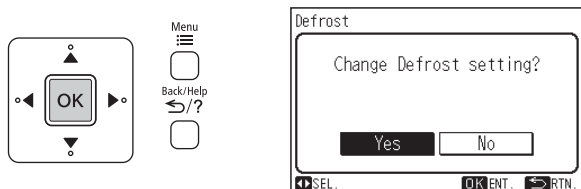

- 7 Select "Yes" by pressing "<" or ">" and press "OK".

The setting will be confirmed and the screen will return to the service menu.

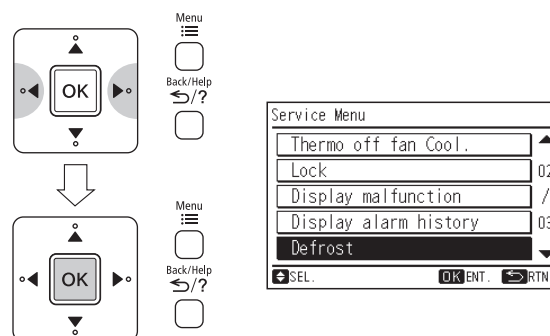

- 8 Press "Back/Help" (return/help) to return to the normal mode.

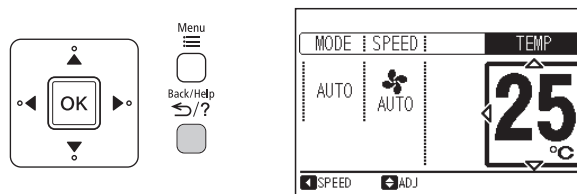

#### NOTE:

- The defrosting inhibit period selection setting will remain unchanged after the unit is turned off.



### 10.2.1.12 ECO AUTO OFF

This function is only available in the model with human detected sensor. When this function is set, the unit will be stopped automatically after set "Auto off time" when nobody is in the room at the eco mode setting.

- 1 Select "ECO AUTO OFF" from the service menu and press "OK".  
The ECO AUTO OFF setting will be displayed.

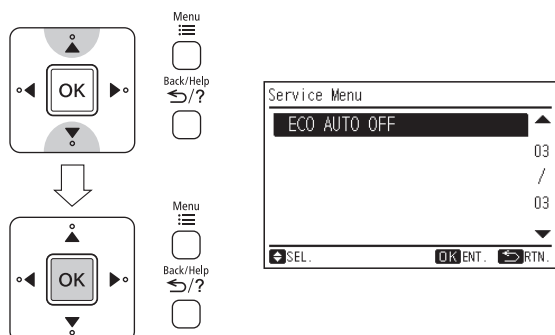

- 2 Press "△" or "▽" to select the setting items. The setting items are displayed "ECO AUTO OFF" and "Auto off time".

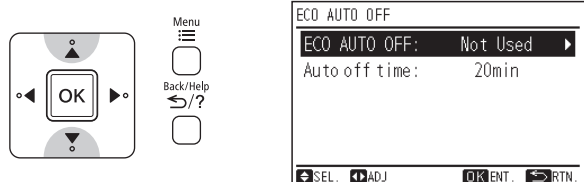

- 3 Press "◀" or "▶" to set each setting content for the selected item. When "ECO AUTO OFF" is selected, the setting contents are switched in order of "Not Used" ↔ "Used" by pressing "◀" or "▶".

When "Auto off time" is selected, the setting time can be set between "20 min" and "120 min" by pressing "◀" or "▶" cyclically. (The set unit is 10 min.)

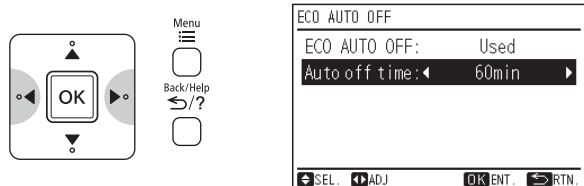

- 4 Press "OK" to finish the ECO AUTO OFF setting. The confirmation screen will be displayed.

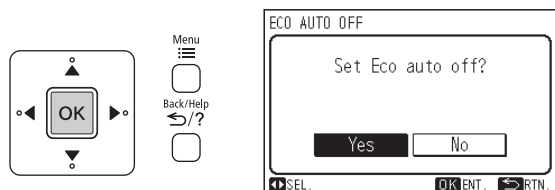

- 5 Select "Yes" by pressing "◀" or "▶" and press "OK". The screen will return to the service menu.

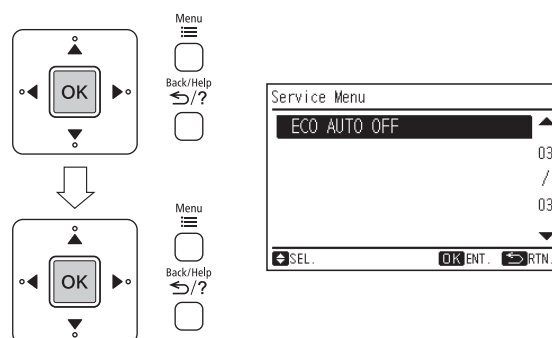

- 6 Press "Back/Help" (return/help) to return to the normal mode.

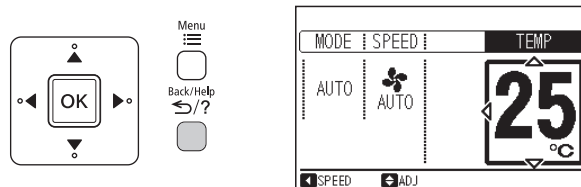

#### NOTE:

- The ECO AUTO OFF setting will remain unchanged after the unit is turned off.
- 7 When the ECO AUTO OFF setting is used, the screen indication will be below.

- (1) If "Eco Auto Off" setting is used, when "Eco" operation is started, "ECO" and "ECO" will be indicated on the screen of normal mode.

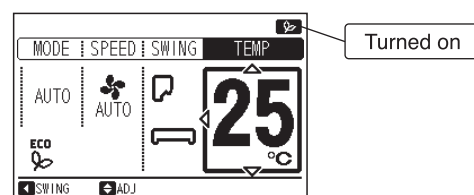

- (2) "ECO Auto Off Mode" will be indicated on the screen of normal mode when the operation is stopped by "ECO AUTO OFF" function.

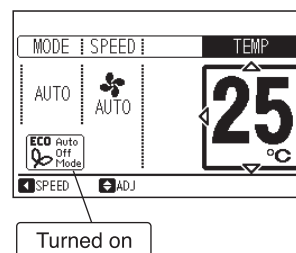

#### NOTE:

If the operation is stopped by "ECO AUTO OFF" function by wireless remote controller, "ECO Auto Off Mode" won't be indicated on the screen of normal mode.



### 10.2.1.13 CLEAN (SERVICE)

Clean(service) can be started. (i.e. FrostWash for outdoor unit)

- 1 Select "Clean(Service)" from the service menu and press "OK".  
Setting item will be displayed.

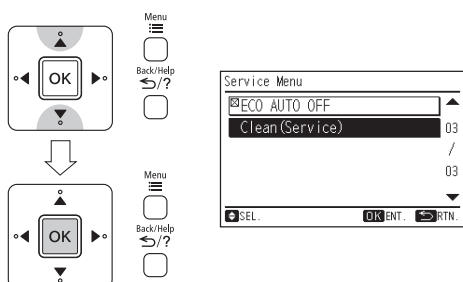

- 2 Press "△" or "▽" to select the setting items. And press "OK".  
The confirmation screen will be displayed.

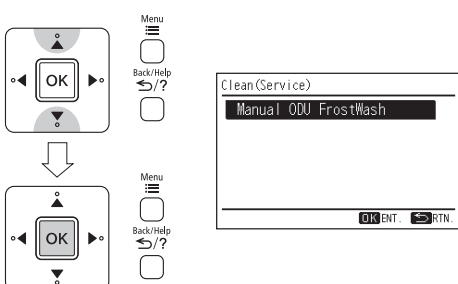

- 3 Select "Yes" by pressing "◀" or "▶" and press "OK".  
The setting will be confirmed and Requesting display will be setting item will be displayed. appeared.

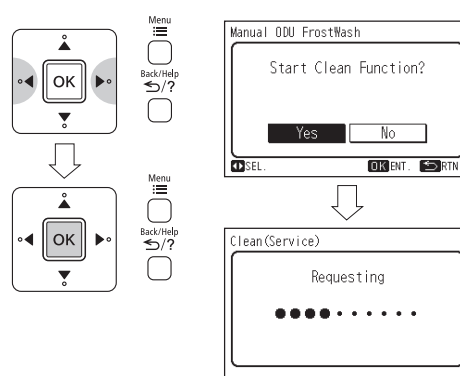

- 4 After a few seconds, Clean(service) will be started.  
The running display will appear.

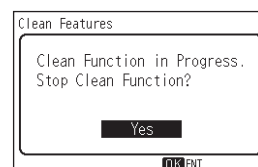

The clean operation will be stopped and the screen will be displayed the normal mode.

#### NOTE

- Based on the temperature condition and etc., Clean(service) might not start. In case of that, the running display will not appear. The display will return to normal mode.
- When clean operation finish, unit will stop automatically.
- If Weekly Timer or Simple Timer is set, Clean (Service) might stop at the middle point because of the timer setting.

### 10.2.1.14 KEY LOCK

This function is used to lock all buttons from the remote controller. When this function is set, the all buttons of remote controller will be locked.

- 1 Setting of the key lock, press "OK" and "ECO" (ECO) simultaneously for 3 seconds.  
"🔒" will be indicated on the screen of normal mode, and the key lock will be set.

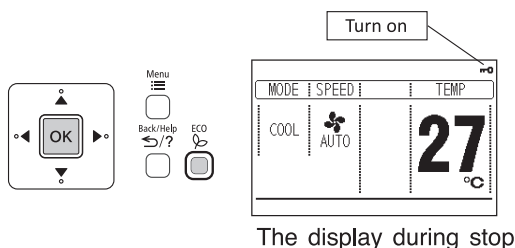

The display during stop

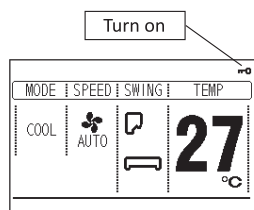

The display during operation

- 2 Cancellation of the key lock, press "OK" and "ECO" (ECO) simultaneously for 3 seconds.  
"🔒" will be turned off, and the key lock will be canceled.

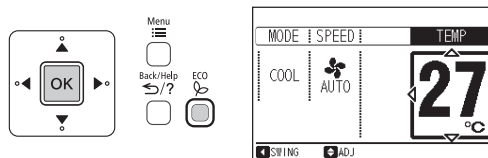

The display during stop

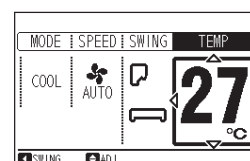

The display during operation

#### NOTE



- Every time pressing "OK" and "ECO" (ECO) simultaneously for 3 seconds, the key lock state will be switched alternately to locked/unlocked.





## 10.2.2 CHECK MENU OPERATION

### 10.2.2.1 SELF CHECKING

Self checking of PCB using this remote controller. The self checking performs to check the remote controller button and to clear EEPROM.

<div><p>(1) Press and hold  and  simultaneously for at least 3 seconds during the normal mode. The check menu will be displayed. Select "Self Checking" from the check menu and press "OK".</p><div><div><div><div>OK</div></div></div><div><div>Menu</div><div>Back/Help</div><div>ECO</div></div></div><div><div>Menu</div><div>Back/Help</div><div>ECO</div></div></div>
---

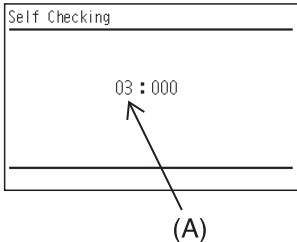
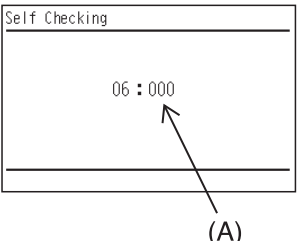

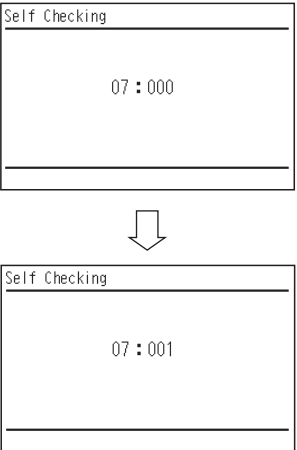
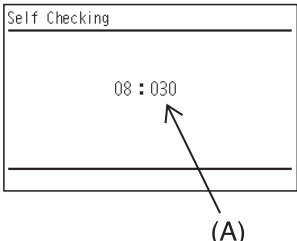
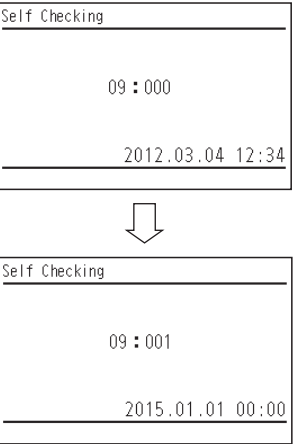
<p>(4) Back light test LCD brightness is changed gradually by pressing "OK"</p>	<p>(A) : 03 : Back light test 04 : Contrast test 05 : Operation indicator test</p> 
<p>(5) Contrast test Contrast of the LCD gradually changes by pressing "OK"</p>	
<p>(6) Operation indicator test Press "OK" and the operation indicator will flash in red and green twice for each.</p>	
<p>(7) Switch input test Press the 9 switched one by one. The number indicated with "(A)" will count up as switch being pressed.</p> <p>* The order of pressing switch is at random. Do not press more than 1(one) button for it will not be counted.</p>	
<p>(8) Transmission circuit test The remote controller automatically starts to check the transmission circuit.</p> <p>* To proceed next step, press "  ".</p>	
<p>(9) Remote controller thermistor test The detected temperature by remote controller thermistor is displayed at "(A)" in the right picture.</p>	
<p>(10) Date/Time test The date and time is switched from "2012.03.04 12:34" to "2015.01.01 00:00".</p>	

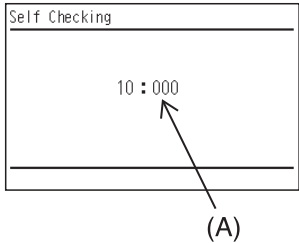
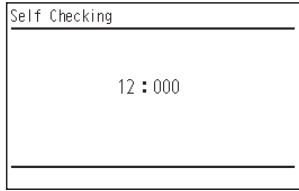
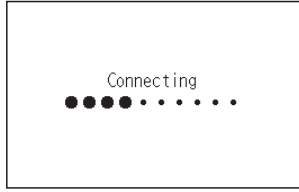

<p>(11) EEPROM test &lt;EEPROM Clearing Cancel&gt; Press " <sup>ECO</sup> ".</p> <p>&lt;EEPROM Clear&gt; Press " OK" or wait 15 seconds. EEPROM data will be cleared. During the process , the numbers will be indicated on where is located with "(A)".</p> <p>If "(A)" has value of "999", EEPROM is in faulty condition. * In case "(A)" has "999", the process does not proceed to next step.</p>	 <p>The image shows a rectangular screen with a title bar at the top that says "Self Checking". Below the title bar, the text "10 : 000" is displayed. A label "(A)" is positioned below the screen, with an arrow pointing to the colon between "10" and "000".</p>
<p>(12) Watchdog Timer test The remote controller will automatically start to check the watchdog timer. After 10 seconds are passed, the self checking is completed and the remote controller is automatically restarted.</p> <p>If does not restart, this check is in faulty condition.</p>	 <p>The image shows a rectangular screen with a title bar at the top that says "Self Checking". Below the title bar, the text "12 : 000" is displayed.</p>
<p>(13) When the self checking is completed, the remote controller is automatically restarted. In this case, "Connecting" is indicated and operation indicator will flash in red. So please turn the circuit breaker OFF and ON.</p>	 <p>The image shows a rectangular screen with the text "Connecting" at the top. Below the text, there is a horizontal row of dots: four solid black dots, followed by a space, then four smaller dots, and finally a period.</p>

## EEPROM process

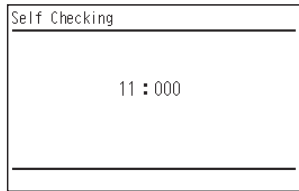
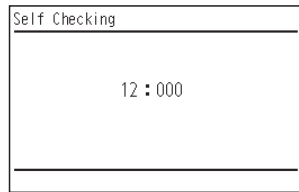
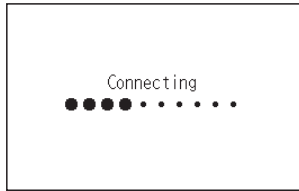
<p>(14) Clear EEPROM The remote controller will automatically restart EEPROM clearing process.</p>	 <p>The image shows a rectangular screen with a title bar at the top that says "Self Checking". Below the title bar, the text "11 : 000" is displayed.</p>
<p>(15) Watchdog Timer test The remote controller will automatically start to check the watchdog timer. After 10 seconds are passed, the self checking is completed and the remote controller is automatically restarted.</p> <p>If does not restart, this check is in faulty condition.</p>	 <p>The image shows a rectangular screen with a title bar at the top that says "Self Checking". Below the title bar, the text "12 : 000" is displayed.</p>
<p>(16) When the process is completed, the remote controller is automatically restarted. In this case, "Connecting" is indicated and operation indicator will flash in red. So please turn the circuit breaker OFF and ON.</p>	 <p>The image shows a rectangular screen with the text "Connecting" at the top. Below the text, there is a horizontal row of dots: four solid black dots, followed by a space, then four smaller dots, and finally a period.</p>



## 10.3 H-LINK ADAPTOR – PSC 6RAD

### 10.3.1 SAFETY SUMMARY

#### DANGER:

- DO NOT pour water into the remote control switch (hereafter called “controller”). This product is equipped with electrical parts. This will cause serious electrical shock.

#### WARNING:

- DO NOT perform installation work and electrical wiring connection by yourself. Contact your distributor or dealer of HITACHI and ask then for installation work and electrical wiring by service person. The specified cable should be used to connect (i) room air conditioner and adaptor, and (ii) controller and adaptor.



#### CAUTION:



- DO NOT install the indoor unit, outdoor unit, controller and cable as such places as:
  - where there is oil vapor and dispersion of oil
  - where there is sulfuric environment (near the hot springs)
  - where there is a flammable gas
  - where there is salty environment (near the sea)
- DO NOT install the indoor unit, outdoor unit, controller and cable within approximately 3 meters from strong electromagnetic wave radiators, such as medical equipment. In case that the controller is installed in a place where there is electromagnetic wave direct-radiation, shield the controller and cables by covering with the steel box and running the cable through the metal conduit tube.
- In case that there is electric noise at the power source for the indoor unit, provide a noise filter.

### 10.3.2 INSTALLATION WORK

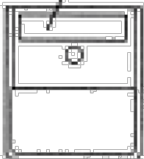
#### ■ Before installation

Check the contents and the number of the accessories in the packing.

Adaptor	 <p>With two 1.8m cables</p>
1 piece of cover for hiding the covering	 <p>Attached 2 sided tapes</p>
Two-sided tape for attaching to Adaptor	 <p>110x40x3mm</p>

2 connectors for H-Link connection		
2 tapping screws for attaching to wall		φ3.0 x 10mm
2 screws for attaching to wooden wall		φ3.1 x 16mm

- 1) RAC adaptor can be installed to the wall as well as on the air conditioner itself
- 2) Install RAC adaptor in the vertical surface as shown below.

Upper side



Mark “↑ UP”

Wiring outlet

Bottom side

- 3) Installation procedure
  - a) When installing to the wall.
    - i) Fix the adaptor with 2 screws. Tapping screw is for metal surface, and other screw is for wooden surface.

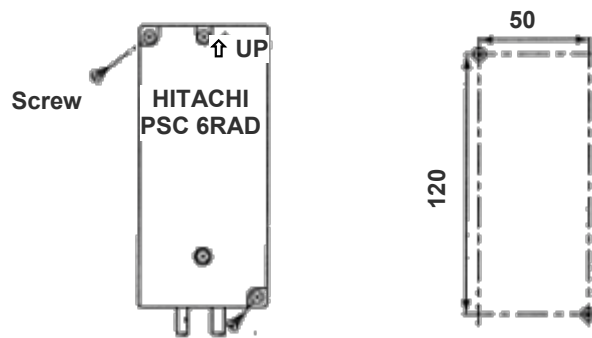

- ii) When using the cover  
It can be installed at the right and left side of room air conditioner. Fix the cover and RAC adaptor with the two-sided tape (accessory).



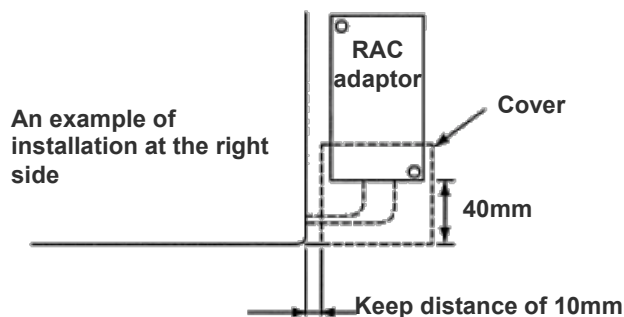

- b) When installing on the room air-conditioner  
In case that it cannot be installed to the wall due to the space or material problem, install the RAC adaptor with the two-sided tape (accessory) on the room air-conditioner.
- Confirm if the piping cover of the unit can be removed when performing the service maintenance, and then fix the RAC adaptor in the side of room air-conditioner with two-sided tape. (Available at the right as well as left side)
  - Clean the surface to be installed with a dry cloth.

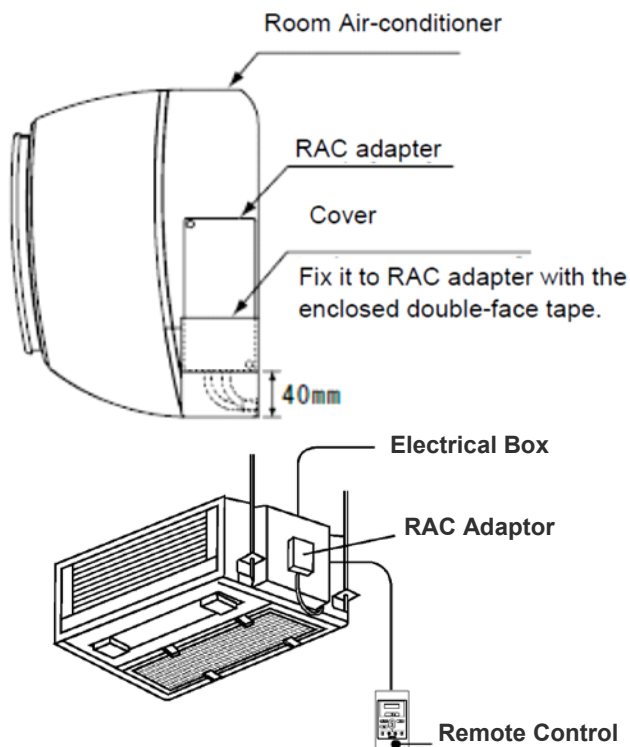

#### NOTE:

- Consider the following points since the adhesiveness changes according to the environmental conditions (temperature, humidity etc)
- The adhesiveness is decreased when there is humidity or oil.
- Warm the adhesive part and installation place of the two-sided tape to avoid the decrease of the adhesiveness in case the ambient temperature is low.
- DO NOT touch the adhesive part by fingers nor re-attach it many times. The adhesiveness has decreased and the RAC adaptor may fall off.
- DO NOT apply any force within 24 hours after installation.

### 10.3.3 ELECTRICAL WIRING

#### ■ System configuration

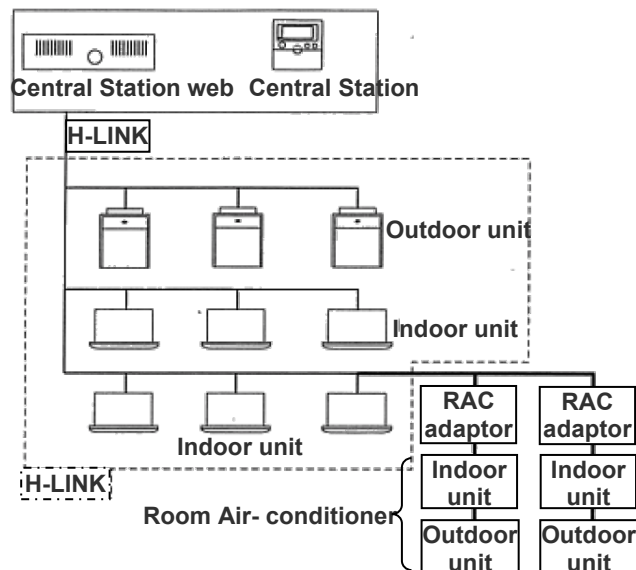

#### CAUTION:

- Turn OFF the power supply of the room air-conditioner of the central control device when performing the wiring work
- DO NOT run all the H-LINK cable or power supply cable along the other signal cable, or malfunction may occur due to the noise, etc. If it is required to run along the other transmission cable, separate the cable more than 30cm, or run the cable through the metal tube and earth the tube.
- Follow local codes and regulations when performing electrical wiring and earth wiring.
- Transmissions cable used in H-LINK shall be 2 cores cable (0.7mm<sup>2</sup> to 1.25mm<sup>2</sup> for model: VCTF, VCT, CVV, MVVX, CVVX, VVR, VVF) or 2 cores twisted pair cable (model: KPEV, KPEV-Spec). Total length of cable shall be below 1000mm.
- DO NOT use wire with more than 3 cores.

#### ■ Internal components and Wiring connections

Check the contents and the number of the accessories in the packing.

- Access  
Open the cover by removing the ① and ② screws.

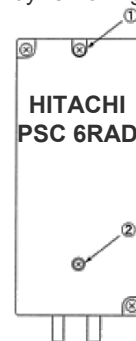

- Wiring Connection  
Connection with Room Air-Conditioner
  - Remove the front cover of the room air-conditioner and the cover of electrical box.
  - The cable attached with the connector of the RAC adaptor shall be connected with the connector of indoor PCB



- iii) Install the electrical box cover paying attention not to clamp the cable. Read the installation manual of each room air-conditioner for confirming how to connect and how to assemble the cable of the RAC adaptor.

**CAUTION:**

- Disconnect the power plug before performing this work
- Turn OFF the break power source in case the power is supplied from the outdoor unit.

- Connection of Transmission Cable

H-LINK transmission cable connecting to RAC adaptor shall be connected to H-LINK.

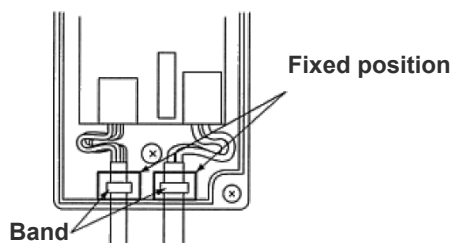
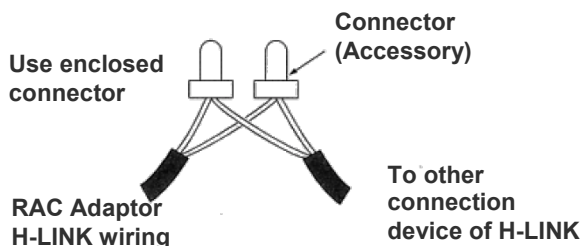
**CAUTION:**

- DO NOT connect incorrect wiring. It may cause the failure of the RAC Adaptor. Especially pay attention not to apply high voltage e.g. AC400/230V.
- DO NOT perform the wiring work while power to the central station or the RAC Adaptor is still being supplied. It may cause malfunction. Turn OFF devices when performing the wiring work.
- The RAC Adaptor side cable should not overload to the connector.
- DO NOT clamp the cable when attaching the RAC adaptor cover.
- Band should not be loose and in fixed position.

**10.3.4 DIP SWITCH SETTING**

- 1) Switch OFF the power of room air conditioner before setting the DIP switch. If the power is ON, the settings are INVALID.
- 2) The position of the DIP switch is shown below.

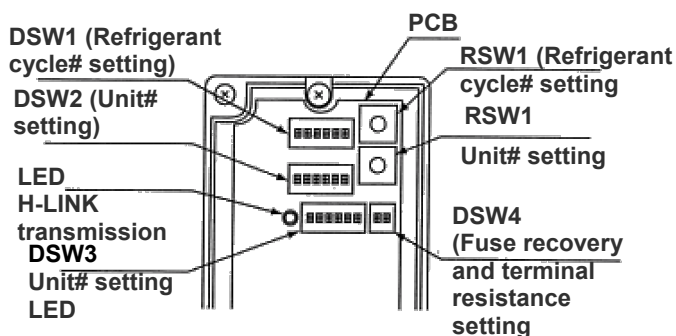
**CAUTION:**

- DO NOT turn ON various pins of DSW1 and DSW2

## 3) Set the refrigerant cycle# by RSW1 and DSW1

DSW1 (Ten digit)	RSW1 (Last digit)
DSW1 and RSW1 are set "0" before shipment. Up to 15 cycles can be set. E.g. Setting in Ref No. 5	
No. 1 pin is OFF	The position is Set 5

## 4) Set the unit No. by RSW2 and DSW2

DSW2 (Ten digit)	RSW2 (Last digit)
DSW2 and RSW3 are set "0" before shipment. Up to 15 cycles can be set. E.g. Setting in Unit No. 15	
No. 1 pin is OFF	The position is Set 5

## 5) Slave unit.

In case of setting various RAC adaptors in the same refrigerant cycle, set the RAC adaptor with smallest Unit# as a master unit. In case of setting only one RAC adaptor in a refrigerant system, this adaptor should be a master unit. Set this procedure by DSW3.

Master Unit setting	Setting before shipping (slave unit setting)

●: Master Unit setting

○: Setting before Shipping (Slave Unit setting)



Refrigerant Unit#	Indoor Unit#									
	0	1	2	3	4	5	6	7		
0	●	○	○	○	○					
1			●	○	○					
2				●	○	○	○	○		
3		●								
4										

**CAUTION:**

- DO NOT set various main adaptors in the same refrigerant cycle.

- 6) Procedure when applying 200V voltage to H-LINK wiring incorrectly.

In case of applying 200V voltage to H-LINK wiring incorrectly, the fuse installed in a transmission circuit on PCB will blow out. In this case, reconnect the wiring correctly and turn ON No. 2 pin of DSW4 on PCB. The transmission circuit can be recovered. (If applying this error again, the transmission circuit can not be recovered)

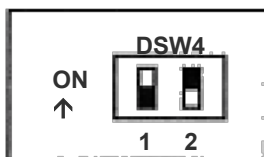
**PCB**

Turn ON No.2 pin of DSW4

- 7) Terminating resistance is set in whole H-LINK system.
- If H-LINK connecting devices like package air-conditioner are connected besides the RAC Adaptor, set the terminating resistance by those connecting devices. The terminating resistance should be set ON in only one position in whole H-LINK system.
  - In case that H-LINK is connected only by the RAC adaptor, set the terminating resistance by the RAC adaptor. The terminating resistance should be set ON in only one position in whole H-LINK system.

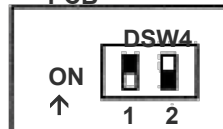
**PCB**

Turn ON No.1 pin of DSW4

**10.3.5 TEST RUN**

Test run should be performed in the following after finishing the installation, wiring and setting. Refer to the installation manuals enclosed with the control system equipment.

- Confirmation of RAC Adaptor Connection  
Confirm if the RAC adaptor connection is recognized in the control system equipments. In case that it is not confirmed, check the transmission cable, refrigerant cycle #, indoor unit #, terminal resistance setting etc.
- Registration  
Confirm if the RAC adaptor connection is recognized.
- Confirmation of RUN/STOP Operation.  
Confirm if the room air-conditioner operate correctly by RUN/STOP from the central control system equipments. Check also if the room air-conditioner operation changes correctly by each setting.



## 10.4 DRY CONTACT (SPX-WDC2 AND SPX-WDC3) APPLICATION (USING DIP SWITCH)

The dry contact system enables the operation of the air conditioner indoor unit to be controlled by using external dry contacts (with non voltage) such as card-key controller or window for facilities such as hotels.

Table 1 (Applicable models and related information)

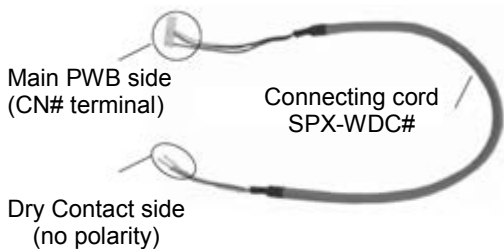
Optional Connecting cord Accessory SPX-WDC#		Model	DIP SW Label	CN#
 <p>Main PWB side (CN# terminal)</p> <p>Connecting cord SPX-WDC#</p> <p>Dry Contact side (no polarity)</p>	SPX-WDC2	RAI-SH07/09/12/18QHAE	SW501	CN5
		RAD-SH07/09/12/18QHAE	SW501	CN5
	SPX-WDC3	RAS-EH07QHAE RAS-EH09/12/18RHAE RAS-SH07QHAE RAS-SH09/12/18RHAE	DSW1	CN6
		RAF-SH07/09/12/18QHAE	DSW1	CN6

### Note:

- 1) DRY CONTACT function is "Enable" by set pin No. 2 of the DIP SWITCH (refer to table 1 for the label) to ON position.
- 2) Select the proper setting for DRY CONTACT LOGIC INPUT pin No. 3 on DIP SWITCH (refer to Table 1 for the label)
  - i) Set to OFF position (Hi Input) if the type of Dry Contact switch to be used (for the CARD KEY UNIT or Window) is of contact type a (Normally Open Type) as shown in below diagram.
  - ii) Set to ON position (Lo Input) if the type of Dry contact switch to be used (for the CARD KEY UNIT or Window) is of contact type b (Normally Close Type) as shown in below diagram.

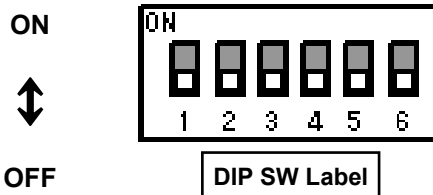





Pin No.	Function	Switch Position / Setting			
		OFF	Disable	ON	Enable
2	DRY CONTACT function				
3	DRY CONTACT Input Logic		HI Input Active		LO Input Active

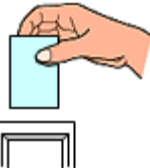
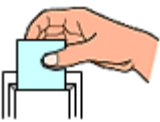

- Please decide the type of dry contact you will be using and set the position of the DIP Switch No. 2 and 3 accordingly

## [1] CHECK DRY CONTACT OF CARD KEY UNIT

	AIR CONDITIONER Standby	AIR CONDITIONER Operating
CARD KEY (Door Switch)	REMOVE 	INSERT 
Contact type a	OPEN 	CLOSE 
Contact type b	CLOSE 	OPEN 

## [2] SET THE POSITION OF DIP SWITCH

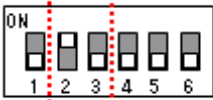
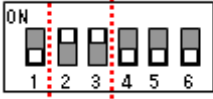
POSITION CONDITION OF DIP SWITCH	
INITIAL CONDITION (CARD KEY NO USE)  No.2 : OFF No.3 : OFF	
 HI Input Active No.2 : ON No.3 : OFF	
 LO Input Active No.2 : ON No.3 : ON	



After all connection has been done as below diagram, ON the breaker and push ON button of wireless remote controller or wired remote controller to operate the air conditioner unit.

- When the CARD KEY is in insert condition, the air conditioner operation is allowable by remote controller.
- When the dry contact switch on the Card Key Unit is open (refer to diagram below for contact type a), the unit stops to operate (it takes 10 seconds to stop the unit operation after the dry contact switch on the card key turns off) and vice versa.
- When the card key is removed from the Card Key Unit, the wireless remote controller cannot be used.
- When the card key is removed from the Card Key Unit, the wired remote controller LCD display is activated; however it has no control over the unit.
- The suitable accessory Connecting Cord (accessory code#: SPX-WDC2 or SPX-WDC3) need to be used to connect the Card Key Unit's dry contact switch to the connector on the control board of the indoor unit. Please refer to Table 1 to select suitable accessory code# for the concerning indoor model.



Example of wiring connection to Card Key Unit will be as below (reference only)

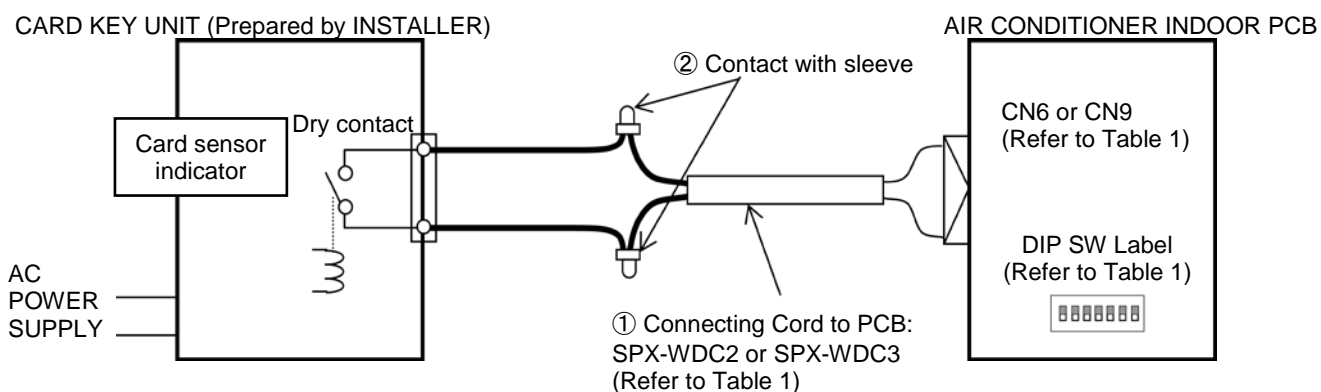

# • CONNECTION EXAMPLE

i. Pin No. 3 of DIP SWITCH is set to OFF position (HI Input Active) for Dry Contact Type a

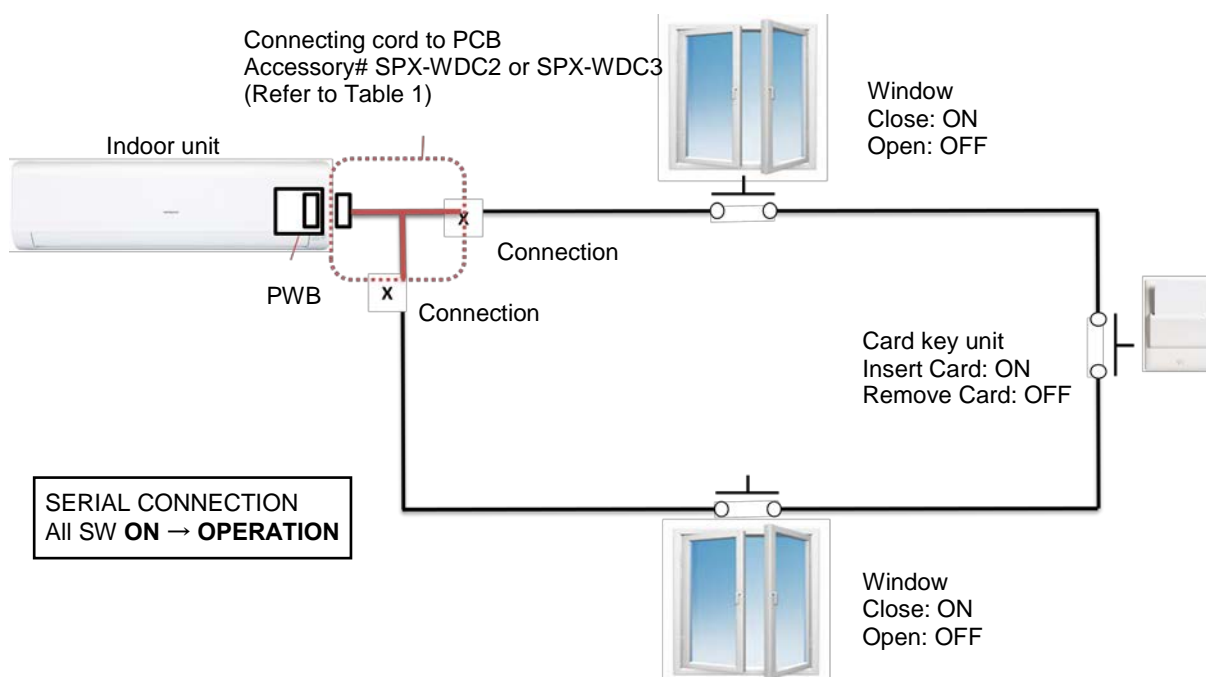

ii. Pin No. 3 of DIP SWITCH is set to ON position (LO Input Active) for Dry Contact Type b

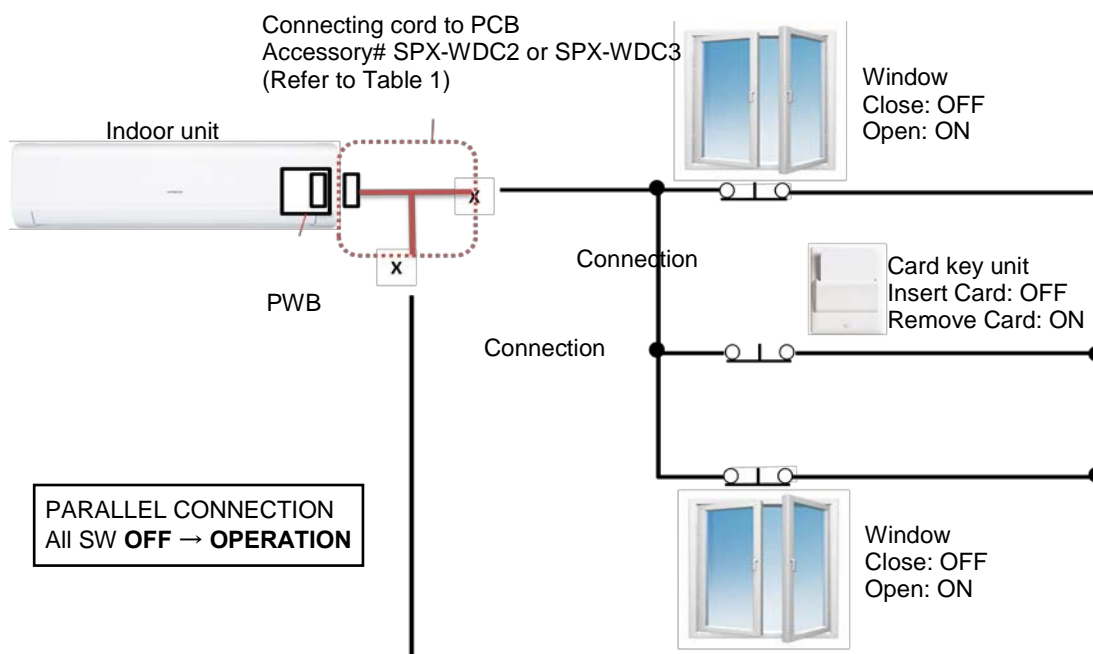

Please refer to the actual manual supplied with the optional connecting cords SPX-WDC2/WDC3 for more details.



## 10.5 DISTRIBUTOR – SPX-DST1

The optional distributor is to be used together with the wired remote controller when there is a need to centralize the control of multiple indoor units using only a single wired remote controller.

A single distributor could be connected further to 3 separate distributors so that up to 13 units of indoor could be controlled by a single wired remote controller.

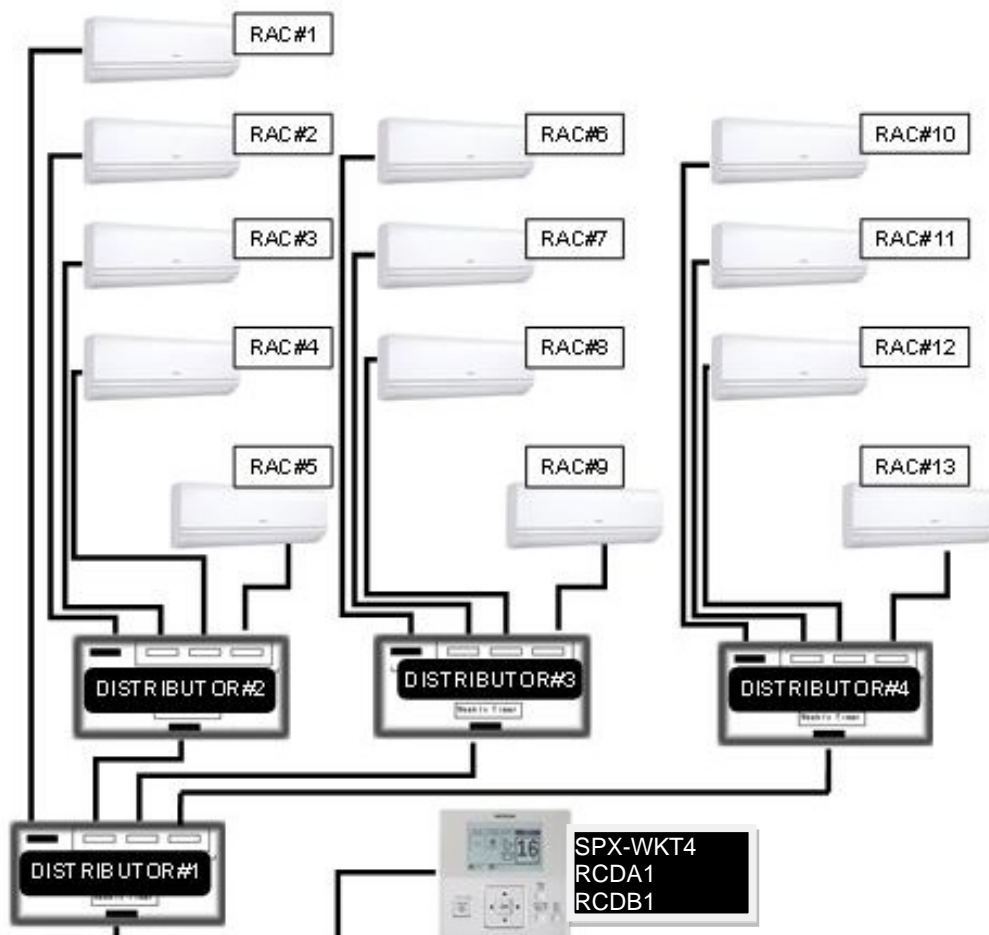
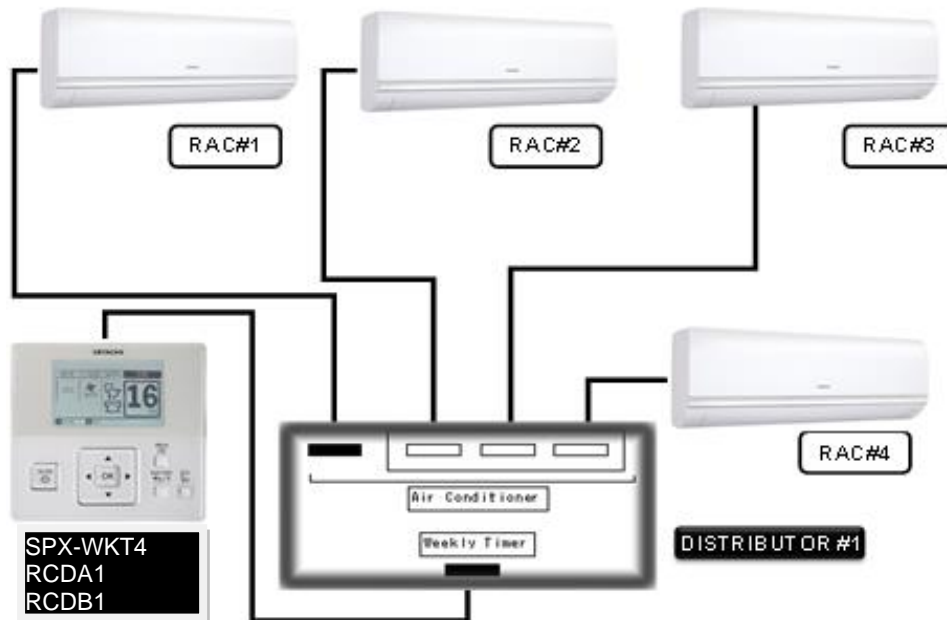



## 10.6 REMOTE SENSOR - SPX-RTH1

This remote sensor is applicable to Duct type indoor unit for Hitachi split system air conditioner.

### 10.6.1 SELECTION OF INSTALLATION POSITION

The thermistor for detecting room temperature is installed inside the remote sensor

The installation position of the remote sensor should be determined in consideration with the following conditions.

- Where the average room temperature can be detected.
- Where is not exposed to the sun
- Where the heat source is not located near the remote sensor.
- Where the discharge air from the air conditioner does not blow directly.
- Where is not affected by the outdoor air when opening / closing the door, etc

### 10.6.2 INSTALLATION PROCEDURE

#### ▪ In case of mounting onto the wall (Fig.1)

- Make the wiring on the sensor box, and let the wires for sensor through the box slot.
- Fix the sensor box onto the wall with 2 screws (B)
- In case that the sensor box can not be fixed onto the wall with screws, fix it onto the wall by using the double sided adhesive tapes, etc.

#### ▪ In case of mounting onto Electrical Switch box (Fig. 2 and 3)

- Make the holes for fixing sensor box on the Switch Box Cover (A) (field-supplied) as shown on the Fig. 3 and fix the sensor box to the plate with screws (B)
- Pay attention that the hole for air intake on the sensor box (C) may not be shut.

Fig. 1

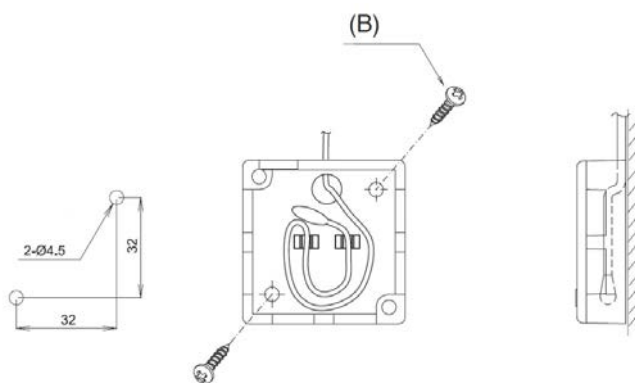

Fig. 2

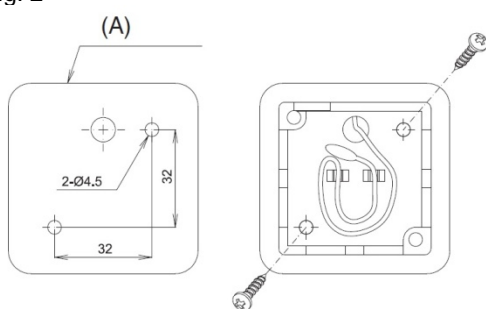
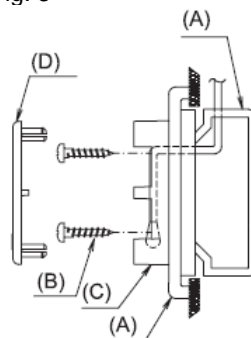

Fig. 3



### 10.6.3 WIRING PROCEDURES

- Remove the original room thermistor from CN1 at the indoor printed circuit board.
- Connect the cord (15m) of the remote sensor to CN1 (Black) of the indoor printed circuit board.

Please refer to the actual manual supplied with the SPX- RTH1 for more details.



Specification in this document are subject to change without notice, in order that Johnson Controls Hitachi Air Conditioning Malaysia Sdn. Bhd. may bring the latest innovations to their customers.

---

**Johnson Controls Hitachi Air Conditioning Malaysia Sdn. Bhd.**

**TC\_ERP-MULTI-R410A(2021)-01**